

# Busch-axcent®

## Individuality with an accent.

Express yourself. Enjoy freedom with bright colours and high gloss surfaces. Such choice brings joy. Each room can have accessories in a different colour, each room can have a different personality. Straight lines and bold edges perfectly correspond with the modern style of furnishing. Primary colours can be used as a colour-key for quick and efficient organisation of appliances and equipment.

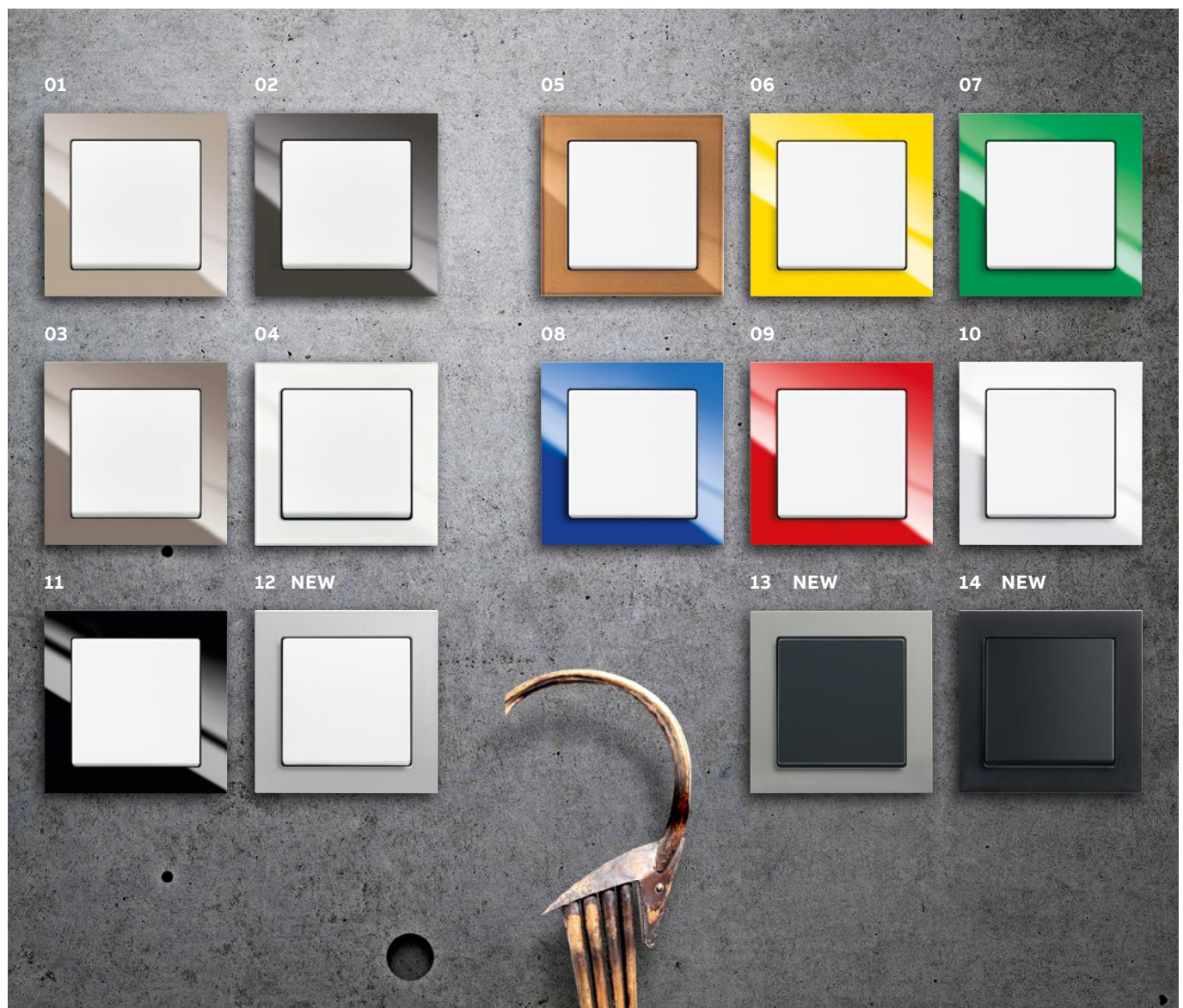

- 01 studio white / maison-beige
- 02 studio white / château-black
- 03 studio white / entrée-grey
- 04 studio white / white glass
- 05 studio white / brown glass
- 06 studio white / yellow
- 07 studio white / green

- 08 studio white / blue
- 09 studio white / red
- 10 studio white / white
- 11 studio white / black
- 12 studio white / titanium
- 13 anthracite / platinum
- 14 black matt / black

### Materials

Cover: Thermoplastic cover (PC), impact-proof and fracture-resistant, UV-resistant, free of PVC and halogen.

## Busch-axcent®

Selected functions.

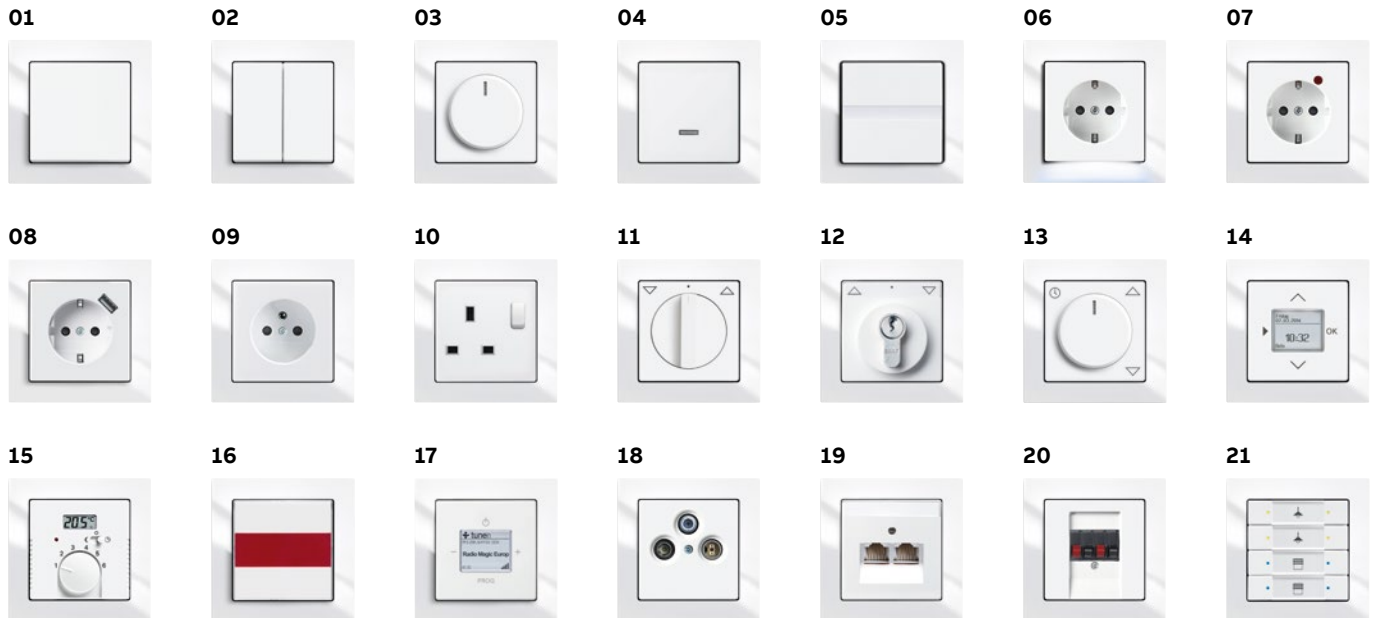

- |    |  |    |   |
|----|--|----|---|
| 01 | Rocker switch 1gang  | 12 | Busch-Blind control switch with semi-cylindrical lock   |
| 02 | Rocker switch 2gang  | 13 | Busch-Blind comfort switch  |
| 03 | Busch Universal Rotary Dimmer                                      | 14 | Comfort timer   |
| 04 | Touch dimmer   | 15 | Room thermostat with display  |
| 05 | Busch-Comfort switch   | 16 | Busch-Infoline® alarm insert  |
| 06 | Busch-steplight®   | 17 | Busch-AudioWorld® Busch-Radio iNet  |
| 07 | Busch-Protector® SCHUKO® socket outlet with overvoltage protection | 18 | Antenna socket for radio/TV/satellite   |
| 08 | SCHUKO® USB socket outlet  | 19 | Universal data connection box   |
| 09 | Socket outlet with earthing pin                                    | 20 | Stereo loudspeaker connecting box   |
| 10 | Switched socket outlet BS standard                                 | 21 | KNX sensor, for more KNX products see part 12 of the catalogue - Intelligent Building Solutions |
| 11 | Blind switch with rotary knob                                      |    |   |

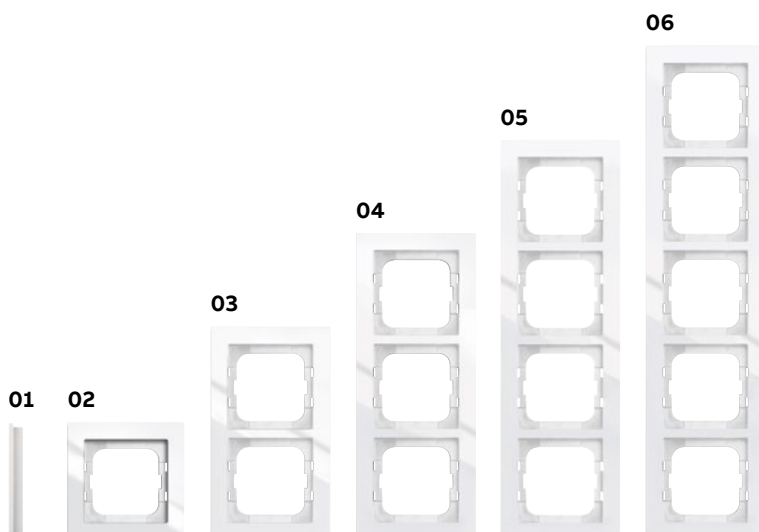

1 to 5gang cover frame for horizontal and vertical installation.

- |    |                          |
|----|--------------------------|
| 01 | Side view, 11 mm x 91 mm |
| 02 | 91 mm x 91 mm            |
| 03 | 91 mm x 162 mm           |
| 04 | 91 mm x 233 mm           |
| 05 | 91 mm x 304 mm           |
| 06 | 91 mm x 375 mm           |



For more information about light switch ranges visit ABB global web sites.

## Busch-axcent®

### Rocker switches / push switches

Product	Article-No.	Order-No.	Pack/Qty
	<b>Rocker Switch Mechanism <sup>1)</sup></b> Rated voltage: 250 V~ Rated current: 10 AX Suitable for: LEDi / CFLi Rated power: 100 W Protection class (Device): IP 20 IEC 60669-1		
	<b>1gang 2way</b>		
	<b>2000/6 US-500</b>	2CKA001012A2198	10/100
	<b>2gang 1way</b>		
	<b>2000/5 US-500</b>	2CKA001012A1150	10/100
	<b>DP, 1gang 2way <sup>2)</sup></b>		
	<b>2000/6/2 US</b>	2CKA001012A0954	10
	<b>1gang</b>		
	<b>2000/7 US-500</b>	2CKA001012A2199	10/100
	<b>DP, 1gang 1way</b>		
<b>2000/2 US-500</b>	2CKA001012A2196	10/100	
<b>SP, 1gang 1way switch</b>			
<b>2000/1 US-500</b>	2CKA001012A2059	10/100	

<sup>1)</sup> Only in conjunction with standard flush-mounting boxes according to DIN 49073, erect or Busch-Jaeger No. 3040 wallbox stonework, 3050 wallbox cavity wall or 3060 wallbox concrete)

<sup>2)</sup> With screw-type terminals. Non-illuminable.

	<b>Rocker Switch Mechanism <sup>1)</sup></b> Rated voltage: 250 V~ Rated current: 16 AX Suitable for: LEDi / CFLi Rated power: 200 W Protection class (Device): IP 20 IEC 60669-1		
	<b>Switch-off and two-way circuit 16 A</b>		
	<b>2400/6 US-500</b>	2CKA001012A2232	10/100
	<b>2gang switch 16 A</b>		
	<b>2400/5 US-500</b>	2CKA001012A2234	10
	<b>1gang intermediate 16 A</b>		
	<b>2400/7 US-500</b>	2CKA001012A2236	10

<sup>1)</sup> Only in conjunction with standard flush-mounting boxes according to DIN 49073, erect or Busch-Jaeger No. 3040 wallbox stonework, 3050 wallbox cavity wall or 3060 wallbox concrete)

	<b>Rocker Switch Mechanism <sup>1)</sup></b> <b>2gang 2way</b> With screwless terminals. Rated voltage: 250 V~ Rated current: 10 AX Suitable for: LEDi / CFLi Rated power: 100 W Protection class (Device): IP 20 IEC 60669-1		
	<b>2000/6/6US-101-500</b>	2CKA001011A0928	10/100

<sup>1)</sup> Only in conjunction with standard flush-mounting boxes according to DIN 49073, erect or Busch-Jaeger No. 3040 wallbox stonework, 3050 wallbox cavity wall or 3060 wallbox concrete)

Product	Article-No.	Order-No.	Pack/Qty
	<b>Rocker Switch Mechanism <sup>1)</sup></b> <b>Changeover/changeover circuit 16 A</b> With screwless terminals. Rated voltage: 250 V~ Rated current: 16 AX Suitable for: LEDi / CFLi Rated power: 200 W Protection class (Device): IP 20 IEC 60669-1		
	<b>2400/6/6US-101-500</b>	2CKA001022A0663	10

<sup>1)</sup> Only in conjunction with standard flush-mounting boxes according to DIN 49073, erect or Busch-Jaeger No. 3040 wallbox stonework, 3050 wallbox cavity wall or 3060 wallbox concrete)

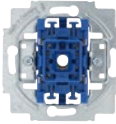
	<b>Rocker Switch Mechanism <sup>1)</sup> <sup>2)</sup></b> <b>DP, 1gang 1way</b> For switching high loads. Rated voltage: 250 V~ Rated current: 16 AX Suitable for: LEDi / CFLi Rated power: 200 W Protection class (Device): IP 20 IEC 60669-1		
	<b>2000/2 US-101-500</b>	2CKA001012A2193	10/100

<sup>1)</sup> Only in conjunction with standard flush-mounting boxes according to DIN 49073, erect or Busch-Jaeger No. 3040 wallbox stonework, 3050 wallbox cavity wall or 3060 wallbox concrete)

<sup>2)</sup> Also for switching SCHUKO® socket outlets.

	<b>Rocker Switch Mechanism <sup>1)</sup> <sup>2)</sup></b> <b>3-pole, 1gang 1way switch</b> Rated voltage: 400 V~ Rated current: 16 AX Suitable for: LEDi / CFLi Rated power: 200 W Protection class (Device): IP 20 IEC 60669-1		
	<b>2000/3 US</b>	2CKA001011A0816	10

<sup>1)</sup> Only in conjunction with standard flush-mounting boxes according to DIN 49073, erect or Busch-Jaeger No. 3040 wallbox stonework, 3050 wallbox cavity wall or 3060 wallbox concrete)

<sup>2)</sup> With screw-type terminals. Non-illuminable.

	<b>Rocker Switch Mechanism <sup>1)</sup></b> With neon lamp. Rated voltage: 250 V~ Rated current: 10 AX Suitable for: LEDi / CFLi Rated power: 100 W Protection class (Device): IP 20 IEC 60669-1		
	<b>1gang 2way <sup>2)</sup></b>		
	<b>2000/6 USGL-500</b>	2CKA001012A2194	10/100
	<b>2gang 1way</b>		
	<b>2000/5 USGL</b>	2CKA001012A1135	10

<sup>1)</sup> Only in conjunction with standard flush-mounting boxes according to DIN 49073, erect or Busch-Jaeger No. 3040 wallbox stonework, 3050 wallbox cavity wall or 3060 wallbox concrete)

<sup>2)</sup> Replacement lamps 8360, 8362, and 8363 and LED inserts.

## Busch-axcent®

### Rocker switches / push switches

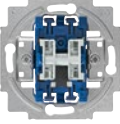
Product	Article-No.	Order-No.	Pack/Qty
 <p><b>Rocker Switch Mechanism, control <sup>1)</sup></b>  <b>2gang switch with N-clamp 16 A</b>            with LED,            Rated voltage: 250 V~            Rated current: 16 AX            Suitable for: LEDi / CFLi            Rated power: 200 W            Protection class (Device): IP 20            IEC 60669-1</p>	<b>2400/5 USK-500</b>	2CKA001012A2238	10

<sup>1)</sup> Only in conjunction with standard flush-mounting boxes according to DIN 49073, erect or Busch-Jaeger No. 3040 wallbox stonework, 3050 wallbox cavity wall or 3060 wallbox concrete)

 <p><b>Rocker Switch Mechanism, control <sup>1)</sup> <sup>2)</sup> <sup>3)</sup></b>            With neon lamp.            Rated voltage: 250 V~            Rated current: 10 AX            Suitable for: LEDi / CFLi            Rated power: 100 W            Protection class (Device): IP 20            IEC 60669-1</p>	<b>1gang 2way with N-terminal</b>		
	<b>2000/6 USK-500</b>	2CKA001022A0659	10/100
<b>DP, 1gang 1way</b>			
<b>2000/2 UK</b>	2CKA001022A0656	10	

<sup>1)</sup> With 1 mA neon lamp.

<sup>2)</sup> Only in conjunction with standard flush-mounting boxes according to DIN 49073, erect or Busch-Jaeger No. 3040 wallbox stonework, 3050 wallbox cavity wall or 3060 wallbox concrete)

<sup>3)</sup> Illuminable by using lamps 8360, 8362, 8363, 8365, 8366, and 8367 and LED inserts.

 <p><b>Rocker Switch Mechanism, control <sup>1)</sup> <sup>2)</sup> <sup>3)</sup></b>  <b>Switch-off and two-way circuit with N-clamp 16 A</b>            With neon lamp.            Rated voltage: 250 V~            Rated current: 16 AX            Suitable for: LEDi / CFLi            Rated power: 200 W            Protection class (Device): IP 20            IEC 60669-1</p>	<b>2400/6 USK-500</b>	2CKA001022A0661	10
---	-----------------------	-----------------	----

<sup>1)</sup> With 1 mA neon lamp.

<sup>2)</sup> Only in conjunction with standard flush-mounting boxes according to DIN 49073, erect or Busch-Jaeger No. 3040 wallbox stonework, 3050 wallbox cavity wall or 3060 wallbox concrete)

<sup>3)</sup> Illuminable by using lamps 8360, 8362, 8363, 8365, 8366, and 8367 and LED inserts.

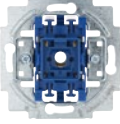
 <p><b>Push-switch mechanism <sup>1)</sup></b>  <b>SP, with normally open contact (operating current)</b>            With N terminal.            Rated voltage: 250 V~            Rated current: 10 A            Protection class (Device): IP 20            IEC 60669-1</p>	<b>2020 US-500</b>	2CKA001413A0574	10/100
---	--------------------	-----------------	--------

<sup>1)</sup> Only in conjunction with standard flush-mounting boxes according to DIN 49073, erect or Busch-Jaeger No. 3040 wallbox stonework, 3050 wallbox cavity wall or 3060 wallbox concrete)

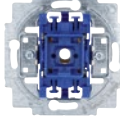
Product	Article-No.	Order-No.	Pack/Qty
 <p><b>Push-switch mechanism <sup>1)</sup></b>  <b>SP, with normally open contact (operating current)</b>            With 2 independent signalling contacts.            Rated voltage: 250 V~            Inputs: 1            Outputs: 1            Rated current: 10 A            Protection class (Device): IP 20            IEC 60669-1</p>	<b>2020 US-201</b>	2CKA001413A0483	10

<sup>1)</sup> Only in conjunction with standard flush-mounting boxes according to DIN 49073, erect or Busch-Jaeger No. 3040 wallbox stonework, 3050 wallbox cavity wall or 3060 wallbox concrete)

 <p><b>Push-switch mechanism <sup>1)</sup> <sup>2)</sup> <sup>3)</sup></b>  <b>SP, with normally open contact (operating current)</b>            With illumination.            With N terminal.            Rated voltage: 250 V~            Rated current: 10 A            Protection class (Device): IP 20            IEC 60669-1</p>	<b>2020 USGL-500</b>	2CKA001413A1106	10/100
---	----------------------	-----------------	--------

<sup>1)</sup> Only in conjunction with standard flush-mounting boxes according to DIN 49073, erect or Busch-Jaeger No. 3040 wallbox stonework, 3050 wallbox cavity wall or 3060 wallbox concrete)

<sup>2)</sup> Replacement lamps 8360, 8362, and 8363 and LED inserts.

<sup>3)</sup> For relay and touch dimmer applications.

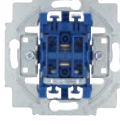
 <p><b>Push-switch mechanism <sup>1)</sup></b>            With one input terminal and 2 actuating covers.            Rated voltage: 250 V~            Inputs: 1            Outputs: 2x Normally open contact            Rated current: 10 A            Protection class (Device): IP 20            IEC 60669-1</p>	<b>2020 US-205-500</b>	2CKA001413A1105	10/100
---	------------------------	-----------------	--------

<sup>1)</sup> Only in conjunction with standard flush-mounting boxes according to DIN 49073, erect or Busch-Jaeger No. 3040 wallbox stonework, 3050 wallbox cavity wall or 3060 wallbox concrete)

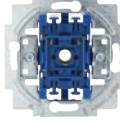
 <p><b>Push-switch mechanism <sup>1)</sup></b>  <b>SP, 1gang 2way</b>            Can be wired for normally open contacts (stand-by current) or normally closed contacts (operating current).            With N terminal.            Rated voltage: 250 V~            Rated current: 10 A            Protection class (Device): IP 20            IEC 60669-1</p>	<b>2020 US-206-500</b>	2CKA001413A1104	10/100
--	------------------------	-----------------	--------

<sup>1)</sup> Only in conjunction with standard flush-mounting boxes according to DIN 49073, erect or Busch-Jaeger No. 3040 wallbox stonework, 3050 wallbox cavity wall or 3060 wallbox concrete)

## Busch-axcent®

### Rocker switches / push switches

Product	Article-No.	Order-No.	Pack/Qty
	<b>Rocker</b> For flush-mounted switch 1g1w, 1g2w, intermediate, push switch. Protection class (Device): IP 20		
anthracite	<b>1786-81-500</b>	2CKA001751A3079	10/100
aluminium silver <sup>1)</sup>	<b>1786-83-500</b>	2CKA001751A3075	10/100
studio white	<b>1786-84-500</b>	2CKA001751A3074	10/100
grey metallic <sup>1)</sup>	<b>1786-803-500</b>	2CKA001751A3093	10/100
studio white, matt <sup>1)</sup>	<b>1786-884-500</b>	2CKA001751A3089	10/100
black matt <sup>1)</sup>	<b>1786-885-500</b>	2CKA001751A3094	10/100

<sup>1)</sup>Surface painted.

	<b>Rocker</b> For flush-mounted switch 2g 1w, 2g push switch. Protection class (Device): IP 20		
anthracite	<b>1785-81</b>	2CKA001751A2930	10
aluminium silver <sup>1)</sup>	<b>1785-83-500</b>	2CKA001751A3092	10/100
studio white	<b>1785-84-500</b>	2CKA001751A3076	10/100
grey metallic <sup>1)</sup>	<b>1785-803</b>	2CKA001751A3018	10/100
antique brass <sup>2)</sup>	<b>1785-840-500</b>	2CKA001751A3117	10
black matt <sup>1)</sup>	<b>1785-885</b>	2CKA001751A3038	10/100

<sup>1)</sup>Surface painted.

<sup>2)</sup>Real metal surface refined by hand.

	<b>Rocker</b> As a cover for flush-mounted control 2gang switch. Protection class (Device): IP 20		
anthracite	<b>1785 K-81-500</b>	2CKA001751A3122	10
aluminium silver <sup>1)</sup>	<b>1785 K-83-500</b>	2CKA001751A3126	10
studio white	<b>1785 K-84-500</b>	2CKA001751A3128	10
grey metallic <sup>1)</sup>	<b>1785 K-803-500</b>	2CKA001751A3130	10
studio white, matt <sup>1)</sup>	<b>1785 K-884-500</b>	2CKA001751A3135	10
black matt <sup>1)</sup>	<b>1785 K-885-500</b>	2CKA001751A3137	10

<sup>1)</sup>Surface painted.

Product	Article-No.	Order-No.	Pack/Qty
	<b>Rocker with small red spherical cap</b> As cover for flush-mounted 1gang 1way, 1gang 2way switch, intermediate switch, push-button and control switch 1gang 2way. Protection class (Device): IP 20		
anthracite	<b>1789-81</b>	2CKA001751A2928	10
aluminium silver <sup>1)</sup>	<b>1789-83</b>	2CKA001751A2945	10/100
studio white	<b>1789-84-500</b>	2CKA001751A3091	10/100
grey metallic <sup>1)</sup>	<b>1789-803</b>	2CKA001751A3013	10
studio white, matt <sup>1)</sup>	<b>1789-884</b>	2CKA001751A3033	10
black matt <sup>1)</sup>	<b>1789-885</b>	2CKA001751A3047	10

<sup>1)</sup>Surface painted.

	<b>Rocker with small transparent lens</b> As cover for flush-mounted 1gang 1way, 1gang 2way switch, intermediate switch, push-button and control switch 1gang 2way. Protection class (Device): IP 20		
anthracite	<b>1789 N-81</b>	2CKA001751A3147	10/100
aluminium silver <sup>1)</sup>	<b>1789 N-83</b>	2CKA001751A3149	10/100
studio white	<b>1789 N-84-500</b>	2CKA001751A3151	10/100
grey metallic <sup>1)</sup>	<b>1789 N-803</b>	2CKA001751A3146	10/100
studio white, matt <sup>1)</sup>	<b>1789 N-884</b>	2CKA001751A3153	10/100
black matt <sup>1)</sup>	<b>1789 N-885</b>	2CKA001751A3154	10/100

<sup>1)</sup>Surface painted.

	<b>Switch rocker with marking</b> With >Light< icon. For flush-mounted switch 1g1w, 1g2w, intermediate, push switch. Protection class (Device): IP 20		
anthracite	<b>2520 LI-81</b>	2CKA001751A3186	10/100
aluminium silver <sup>1)</sup>	<b>2520 LI-83</b>	2CKA001751A3188	10/100
studio white	<b>2520 LI-84-500</b>	2CKA001751A3190	10/100
grey metallic <sup>1)</sup>	<b>2520 LI-803</b>	2CKA001751A3185	10/100
studio white, matt <sup>1)</sup>	<b>2520 LI-884</b>	2CKA001751A3192	10/100
black matt <sup>1)</sup>	<b>2520 LI-885</b>	2CKA001751A3193	10/100

<sup>1)</sup>Surface painted.

## Busch-axcent®

### Rocker switches / push switches

Product	Article-No.	Order-No.	Pack/Qty
	<b>Switch rocker with marking</b> With >Key< icon. For flush-mounted push switch. Protection class (Device): IP 20		
anthracite	<b>2520 TR-81</b>	2CKA001751A3196	10/100
aluminium silver <sup>1)</sup>	<b>2520 TR-83</b>	2CKA001751A3198	10/100
studio white	<b>2520 TR-84</b>	2CKA001751A3199	10/100
grey metallic <sup>1)</sup>	<b>2520 TR-803</b>	2CKA001751A3195	10/100
studio white, matt <sup>1)</sup>	<b>2520 TR-884</b>	2CKA001751A3201	10/100
black matt <sup>1)</sup>	<b>2520 TR-885</b>	2CKA001751A3202	10/100

<sup>1)</sup>Surface painted.

	<b>Switch rocker with marking</b> With >Bell< icon. For flush-mounted push switch. Protection class (Device): IP 20		
anthracite	<b>2520 KI-81</b>	2CKA001751A3176	10/100
aluminium silver <sup>1)</sup>	<b>2520 KI-83</b>	2CKA001751A3178	10/100
studio white	<b>2520 KI-84-500</b>	2CKA001751A3180	10/100
grey metallic <sup>1)</sup>	<b>2520 KI-803</b>	2CKA001751A3175	10/100
studio white, matt <sup>1)</sup>	<b>2520 KI-884</b>	2CKA001751A3182	10/100
black matt <sup>1)</sup>	<b>2520 KI-885</b>	2CKA001751A3183	10/100

<sup>1)</sup>Surface painted.

	<b>Switch rocker with marking</b> <b>with small transparent lens</b> With >Light< icon. As cover for flush-mounted 1gang 1way, 1gang 2way switch, intermediate switch, push-button and control switch 1gang 2way. Protection class (Device): IP 20		
anthracite	<b>1789 LI-81</b>	2CKA001751A2931	10
aluminium silver <sup>1)</sup>	<b>1789 LI-83</b>	2CKA001751A2951	10
studio white	<b>1789 LI-84-500</b>	2CKA001751A3084	10/100
grey metallic <sup>1)</sup>	<b>1789 LI-803</b>	2CKA001751A3014	10
studio white, matt <sup>1)</sup>	<b>1789 LI-884</b>	2CKA001751A3031	10
black matt <sup>1)</sup>	<b>1789 LI-885</b>	2CKA001751A3045	10

<sup>1)</sup>Surface painted.

Product	Article-No.	Order-No.	Pack/Qty
	<b>Switch rocker with marking</b> <b>with small transparent lens</b> With >Plug< icon. As cover for flush-mounted switch 1g1w DP and 3pole with neon lens and marking "I O" As cover for flush-mounted 1gang 1way, 1gang 2way switch, intermediate switch, push-button and control switch 1gang 2way. Protection class (Device): IP 20		
anthracite	<b>1789 ST-81</b>	2CKA001751A3157	10/100
aluminium silver <sup>1)</sup>	<b>1789 ST-83</b>	2CKA001751A3159	10/100
studio white	<b>1789 ST-84-500</b>	2CKA001751A3161	10/100
grey metallic <sup>1)</sup>	<b>1789 ST-803</b>	2CKA001751A3156	10/100
studio white, matt <sup>1)</sup>	<b>1789 ST-884</b>	2CKA001751A3163	10/100
black matt <sup>1)</sup>	<b>1789 ST-885</b>	2CKA001751A3164	10/100

<sup>1)</sup>Surface painted.

	<b>Switch rocker with marking</b> <b>with small transparent lens</b> With >Key< icon. For flush-mounted push switch. Protection class (Device): IP 20		
anthracite	<b>1789 TR-81</b>	2CKA001751A2933	10
aluminium silver <sup>1)</sup>	<b>1789 TR-83</b>	2CKA001751A2953	10
studio white	<b>1789 TR-84</b>	2CKA001751A2755	10
grey metallic <sup>1)</sup>	<b>1789 TR-803</b>	2CKA001751A3016	10
studio white, matt <sup>1)</sup>	<b>1789 TR-884</b>	2CKA001751A3032	10
black matt <sup>1)</sup>	<b>1789 TR-885</b>	2CKA001751A3046	10

<sup>1)</sup>Surface painted.

	<b>Switch rocker with marking</b> <b>with small transparent lens</b> With >Bell< icon. For flush-mounted push switch. Protection class (Device): IP 20		
anthracite	<b>1789 KI-81</b>	2CKA001751A2932	10
aluminium silver <sup>1)</sup>	<b>1789 KI-83</b>	2CKA001751A2952	10
studio white	<b>1789 KI-84</b>	2CKA001751A2754	10
grey metallic <sup>1)</sup>	<b>1789 KI-803</b>	2CKA001751A3015	10
studio white, matt <sup>1)</sup>	<b>1789 KI-884</b>	2CKA001751A3030	10
black matt <sup>1)</sup>	<b>1789 KI-885</b>	2CKA001751A3044	10

<sup>1)</sup>Surface painted.

## Busch-axcent®

### Rocker switches / push switches

Product	Article-No.	Order-No.	Pack/Qty
---------	-------------	-----------	----------



**Rocker <sup>1) 2)</sup> with labelling field**  
With pilot lamp for uniform illumination of the labelling field.  
For flush-mounted switch 1g1w, 1g2w, intermediate, push switch.  
Size of labelling field: 59.7 x 11.7 mm.  
Protection class (Device): IP 20

anthracite	<b>1764 NLI-81</b>	2CKA001731A1552	10
aluminium silver <sup>3)</sup>	<b>1764 NLI-83</b>	2CKA001731A1948	10
studio white	<b>1764 NLI-84</b>	2CKA001731A1877	10/100
grey metallic <sup>3)</sup>	<b>1764 NLI-803</b>	2CKA001731A1975	10
studio white, matt <sup>3)</sup>	<b>1764 NLI-884</b>	2CKA001731A1985	10
black matt <sup>3)</sup>	<b>1764 NLI-885</b>	2CKA001731A1982	10

<sup>1)</sup> For compatible lettering software, visit [www.BUSCH-JAEGER-labelingtool.com](http://www.BUSCH-JAEGER-labelingtool.com).

<sup>2)</sup> Illumination using neon lamp 8353 or incandescent lamp 8344-1 and LED inserts.

<sup>3)</sup> Surface painted.



**Rocker <sup>1) 2)</sup> with labelling field**  
With >Bell< icon.  
With pilot lamp for uniform illumination of the labelling field.  
For flush-mounted push switch.  
Size of labelling field: 59.7 x 11.7 mm.  
Protection class (Device): IP 20

anthracite	<b>1764 NLI/KI-81</b>	2CKA001731A3998	10/100
aluminium silver <sup>3)</sup>	<b>1764 NLI/KI-83</b>	2CKA001731A4000	10/100
studio white	<b>1764 NLI/KI-84-500</b>	2CKA001731A4002	10/100
grey metallic <sup>3)</sup>	<b>1764 NLI/KI-803</b>	2CKA001731A3997	10/100
studio white, matt <sup>3)</sup>	<b>1764 NLI/KI-884</b>	2CKA001731A4004	10/100
black matt <sup>3)</sup>	<b>1764 NLI/KI-885</b>	2CKA001731A4005	10/100

<sup>1)</sup> For compatible lettering software, visit [www.BUSCH-JAEGER-labelingtool.com](http://www.BUSCH-JAEGER-labelingtool.com).

<sup>2)</sup> Illumination using neon lamp 8353 or incandescent lamp 8344-1 and LED inserts.

<sup>3)</sup> Surface painted.



**Switch rocker with marking with small red spherical cap**  
With imprint >0< and >1<.  
As cover for 2-pole or 3-pole flush-mounted on-off switch and 2-pole control on-off switch.  
Protection class (Device): IP 20

anthracite	<b>1788-81</b>	2CKA001751A2927	10
aluminium silver <sup>1)</sup>	<b>1788-83</b>	2CKA001751A2954	10
studio white	<b>1788-84</b>	2CKA001751A2750	10/100
grey metallic <sup>1)</sup>	<b>1788-803</b>	2CKA001751A3017	10
studio white, matt <sup>1)</sup>	<b>1788-884</b>	2CKA001751A3028	10
black matt <sup>1)</sup>	<b>1788-885</b>	2CKA001751A3042	10

<sup>1)</sup> Surface painted.

Product	Article-No.	Order-No.	Pack/Qty
---------	-------------	-----------	----------



**Switch rocker with marking with small red spherical cap**  
With >Heating< imprint.  
As cover for flush-mounted 1gang 1way, 1gang 2way switch, intermediate switch, push-button and control switch 1gang 2way.  
As cover for 2-pole or 3-pole flush-mounted on-off switch and 2-pole control on-off switch.  
Protection class (Device): IP 20

anthracite	<b>1789 H-81</b>	2CKA001751A2929	10
aluminium silver <sup>1)</sup>	<b>1789 H-83</b>	2CKA001751A2955	10
studio white	<b>1789 H-84</b>	2CKA001751A2751	10
grey metallic <sup>1)</sup>	<b>1789 H-803</b>	2CKA001751A3019	10
studio white, matt <sup>1)</sup>	<b>1789 H-884</b>	2CKA001751A3029	10
black matt <sup>1)</sup>	<b>1789 H-885</b>	2CKA001751A3043	10

<sup>1)</sup> Surface painted.

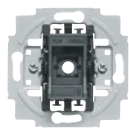

**Card switch 10 A <sup>1)</sup> SP, with normally open contact (operating current)**  
Illuminable.  
With N terminal.  
Rated voltage: 250 V~  
Rated current: 10 A  
Suitable for: LEDi / CFLi  
Rated power: 100 W  
Protection class (Device): IP 20 IEC60669-1, British Standard EN 60669-1

**2025 U** 2CKA001012A1713 10

**Mounting boxes:** 35 mm deep flush 1gang or Dual Box 3070-2/35 BSDB.

**2gang product combinations:** 2gang combination with adapter plate APBS in Dual Box only.

**delivery form:** Adapter plate APBS to be ordered separate.

<sup>1)</sup> Only in conjunction with standard flush-mounting boxes according to DIN 49073, erect or Busch-Jaeger No. 3040 wallbox stonework, 3050 wallbox cavity wall or 3060 wallbox concrete)



**Cover plate**  
For card switch.  
For insert 2025 U.  
Suitable for cards sized 54 x 86 mm.  
The inner part of the cover plate is made of light-conducting plastic, so that the card slot is illuminated.  
Protection class (Device): IP 20

anthracite	<b>1792-81</b>	2CKA001710A3639	10
aluminium silver <sup>1)</sup>	<b>1792-83</b>	2CKA001710A3670	10
studio white	<b>1792-84</b>	2CKA001710A3641	10
grey metallic <sup>1)</sup>	<b>1792-803</b>	2CKA001710A4124	10
studio white, matt <sup>1)</sup>	<b>1792-884</b>	2CKA001710A3928	10
black matt <sup>1)</sup>	<b>1792-885</b>	2CKA001710A3905	10

<sup>1)</sup> Surface painted.

## Busch-axcent®

### Rocker switches / push switches

Product	Article-No.	Order-No.	Pack/Qty
	<b>Switch rocker with marking</b> For flush-mounted switch 1g1w, 1g2w, intermediate, push switch. DO NOT DISTURB Protection class (Device): IP 20		
anthracite	<b>1786/11-81</b>	2CKA001751A3207	10
aluminium silver <sup>1)</sup>	<b>1786/11-83</b>	2CKA001751A3001	10
studio white	<b>1786/11-84</b>	2CKA001751A2998	10
grey metallic <sup>1)</sup>	<b>1786/11-803</b>	2CKA001751A3206	10
studio white, matt <sup>1)</sup>	<b>1786/11-884</b>	2CKA001751A3026	10
black matt <sup>1)</sup>	<b>1786/11-885</b>	2CKA001751A3040	10

<sup>1)</sup> Surface painted.

	<b>Switch rocker with marking</b> For flush-mounted switch 2g 1w, 2g push switch. DO NOT DISTURB MAKE UP ROOM Protection class (Device): IP 20		
anthracite	<b>1785/11-81</b>	2CKA001751A3205	10
aluminium silver <sup>1)</sup>	<b>1785/11-83</b>	2CKA001751A2995	10
studio white	<b>1785/11-84</b>	2CKA001751A2992	10
grey metallic <sup>1)</sup>	<b>1785/11-803</b>	2CKA001751A3204	10
studio white, matt <sup>1)</sup>	<b>1785/11-884</b>	2CKA001751A3023	10
black matt <sup>1)</sup>	<b>1785/11-885</b>	2CKA001751A3037	10

<sup>1)</sup> Surface painted.

	<b>Switch rocker with marking</b> As cover for flush-mounted rocker control switch insert, DND/MUR. DO NOT DISTURB MAKE UP ROOM Protection class (Device): IP 20		
anthracite	<b>1785/11 K-81</b>	2CKA001751A3212	10
aluminium silver <sup>1)</sup>	<b>1785/11 K-83</b>	2CKA001751A3210	10
studio white	<b>1785/11 K-84</b>	2CKA001751A3209	10
grey metallic <sup>1)</sup>	<b>1785/11 K-803</b>	2CKA001751A3215	10
studio white, matt <sup>1)</sup>	<b>1785/11 K-884</b>	2CKA001751A3211	10
black matt <sup>1)</sup>	<b>1785/11 K-885</b>	2CKA001751A3213	10

<sup>1)</sup> Surface painted.

Product	Article-No.	Order-No.	Pack/Qty
	<b>Bell push-switch DND/MUR 230 V <sup>1)</sup></b> with LED, Rated voltage: 250 V~ Rated current: 10 A Protection class (Device): IP 20 IEC 60669-1		
anthracite	<b>2029 UC-81</b>	2CKA001751A3167	1
aluminium silver <sup>2)</sup>	<b>2029 UC-83</b>	2CKA001751A3169	1
studio white	<b>2029 UC-84</b>	2CKA001751A3170	1
grey metallic <sup>2)</sup>	<b>2029 UC-803</b>	2CKA001751A3166	1
studio white, matt <sup>2)</sup>	<b>2029 UC-884</b>	2CKA001751A3172	1
black matt <sup>2)</sup>	<b>2029 UC-885</b>	2CKA001751A3173	1

<sup>1)</sup> Only in conjunction with standard flush-mounting boxes according to DIN 49073, erect or Busch-Jaeger No. 3040 wallbox stonework, 3050 wallbox cavity wall or 3060 wallbox concrete)

<sup>2)</sup> Surface painted.

	<b>Bell push-switch DND/MUR 24 V <sup>1)</sup></b> with LED, Rated voltage: 24 V Rated current: 6 A Protection class (Device): IP 20 IEC 60669-1		
anthracite	<b>2029/12 UC-81</b>		1
aluminium silver <sup>2)</sup>	<b>2029/12 UC-83</b>	2CKA001751A3232	1
studio white	<b>2029/12 UC-84</b>	2CKA001751A3231	1
grey metallic <sup>2)</sup>	<b>2029/12 UC-803</b>	2CKA001751A3237	1
studio white, matt <sup>2)</sup>	<b>2029/12 UC-884</b>	2CKA001751A3233	1
black matt <sup>2)</sup>	<b>2029/12 UC-885</b>	2CKA001751A3235	1

<sup>1)</sup> Only in conjunction with standard flush-mounting boxes according to DIN 49073, erect or Busch-Jaeger No. 3040 wallbox stonework, 3050 wallbox cavity wall or 3060 wallbox concrete)

<sup>2)</sup> Surface painted.

	<b>Pull switch <sup>1)</sup></b> <b>SP, with normally open contact (operating current)</b> With 2-metre pull cord, red handle, and red neon indicator. Rated voltage: 250 V~ Rated current: 10 A		
	<b>2020/01 US-101</b>	2CKA001413A1112	10

<sup>1)</sup> Only in conjunction with standard flush-mounting boxes according to DIN 49073, erect or Busch-Jaeger No. 3040 wallbox stonework, 3050 wallbox cavity wall or 3060 wallbox concrete)

	<b>Pull switch <sup>1)</sup></b> <b>SP, break contact</b> With 2-metre pull cord, red handle, and red neon indicator. Rated voltage: 250 V~ Rated current: 10 A		
	<b>2020/10 US-101</b>	2CKA001413A1111	10

<sup>1)</sup> Only in conjunction with standard flush-mounting boxes according to DIN 49073, erect or Busch-Jaeger No. 3040 wallbox stonework, 3050 wallbox cavity wall or 3060 wallbox concrete)



## Busch-axcent®

### Rocker switches / push switches

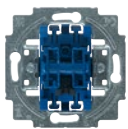
Product	Article-No.	Order-No.	Pack/Qty
 <p><b>Rocker switch insert DND/MUR 1)</b> with LED, Rated voltage: 250 V~ Rated current: 10 AX Suitable for: LEDi / CFLi Rated power: 100 W Protection class (Device): IP 20 IEC 60669-1</p>	<b>2028 UK</b>	2CKA001012A2240	10/100

<sup>1)</sup> Only in conjunction with standard flush-mounting boxes according to DIN 49073, erect or Busch-Jaeger No. 3040 wallbox stonework, 3050 wallbox cavity wall or 3060 wallbox concrete)

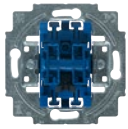
 <p><b>Rocker switch insert DND/MUR 1)</b> with LED, Rated voltage: 24 V Rated current: 6 A Protection class (Device): IP 20 IEC 60669-1</p>	<b>2028/12 UK</b>	2CKA001012A2241	10/100
---	-------------------	-----------------	--------

<sup>1)</sup> Only in conjunction with standard flush-mounting boxes according to DIN 49073, erect or Busch-Jaeger No. 3040 wallbox stonework, 3050 wallbox cavity wall or 3060 wallbox concrete)

 <p><b>Cover plate 1)</b> <b>for pull switch 2610/6 UC-xx, 2610/6 UJ-xx</b> With screw-type terminal Protection class (Device): IP 20</p>	anthracite	<b>1796-81</b>	2CKA001753A0308	10
	aluminium silver <sup>2)</sup>	<b>1796-83</b>	2CKA001753A0310	10
studio white	<b>1796-84</b>	2CKA001753A0311	10	
grey metallic <sup>2)</sup>	<b>1796-803</b>	2CKA001753A0307	10	
studio white, matt <sup>2)</sup>	<b>1796-884</b>	2CKA001753A0313	10	
black matt <sup>2)</sup>	<b>1796-885</b>	2CKA001753A0314	10	

<sup>1)</sup> Exchanging the available cover/cover plate.

<sup>2)</sup> Surface painted.

 <p><b>Rocker open for red pull switch neon indicator</b> For pull switch 2020/xx US. Protection class (Device): IP 20</p>	anthracite	<b>1720-81</b>	2CKA001731A1914	10
	aluminium silver <sup>1)</sup>	<b>1720-83</b>	2CKA001731A1949	10
studio white	<b>1720-84</b>	2CKA001731A1916	10	
studio white, matt <sup>1)</sup>	<b>1720-884</b>	2CKA001731A1979	10	
black matt <sup>1)</sup>	<b>1720-885</b>	2CKA001731A1981	10	

<sup>1)</sup> Surface painted.

Product	Article-No.	Order-No.	Pack/Qty
 <p><b>Three-step rotary switch 1) 2)</b> <b>SP, with zero position</b> With zero position. Rated voltage: 250 V~ Rated current: 16 A Protection class (Device): IP 20</p>	<b>2710 U</b>	2CKA001101A0918	1/10

<sup>1)</sup> Install only in conjunction with wall boxes ø 60 mm.

<sup>2)</sup> Not to be mounted in SM box 1701-xxx, 1702-xxx, 1703-xxx.

 <p><b>Three-step rotary switch 1) 2)</b> <b>SP, without zero position</b> Without zero position. Rated voltage: 250 V~ Rated current: 16 A Protection class (Device): IP 20</p>	<b>2710/1 U</b>	2CKA001101A0919	1/10
---	-----------------	-----------------	------

<sup>1)</sup> Install only in conjunction with wall boxes ø 60 mm.

<sup>2)</sup> Not to be mounted in SM box 1701-xxx, 1702-xxx, 1703-xxx.

 <p><b>Cover plate with rotary control, with marking</b> As cover for flush mounted three-step rotary switch. With zero position. For insert 2710 U. Protection class (Device): IP 20</p>	anthracite	<b>2542 DR/01-81</b>	2CKA001710A3644	10
	aluminium silver <sup>1)</sup>	<b>2542 DR/01-83</b>	2CKA001710A3671	10
studio white	<b>2542 DR/01-84</b>	2CKA001710A3646	10	
grey metallic <sup>1)</sup>	<b>2542 DR/01-803</b>	2CKA001710A4125	10	
studio white, matt <sup>1)</sup>	<b>2542 DR/01-884</b>	2CKA001710A3890	10	
black matt <sup>1)</sup>	<b>2542 DR/01-885</b>	2CKA001710A3913	10	



<sup>1)</sup> Surface painted.

 <p><b>Cover plate with rotary control, with marking</b> As cover for flush mounted three-step rotary switch. Without zero position. For insert 2710/1 U. Protection class (Device): IP 20</p>	anthracite	<b>2542 DR/02-81</b>	2CKA001710A3649	10
	aluminium silver <sup>1)</sup>	<b>2542 DR/02-83</b>	2CKA001710A3672	10
studio white	<b>2542 DR/02-84</b>	2CKA001710A3651	10	
grey metallic <sup>1)</sup>	<b>2542 DR/02-803</b>	2CKA001710A4126	10	
studio white, matt <sup>1)</sup>	<b>2542 DR/02-884</b>	2CKA001710A3891	10	
black matt <sup>1)</sup>	<b>2542 DR/02-885</b>	2CKA001710A3914	10	







<sup>1)</sup> Surface painted.

# Busch-axcent®

## Dimmers

Product	Article-No.	Order-No.	Pack/Qty
	<b>Friends of Hue smart switch insert Wall-mounted transmitter, 2 channel</b>		
	For Friends of Hue smart switch Rocker 6736 FoH-8xx. Smarter light switches for wireless remote control of Philips Hue lamps		
	For switching and dimming of Philips Hue lamps.		
	For saving, calling up and dimming of a maximum of 2 individual light scenes.		
	Without battery and maintenance-free due to >Energy harvesting<.		
	Maximum safety of function by means of Zigbee-Mesh technology.		
	Requires Philips Hue Bridge (2nd generation; square construction type) and Philips Hue app (Version 3.2 or higher).		
	Combinable with the Busch-Jaeger switch ranges carat®, Busch-dynasty®, pure stainless steel, solo®, Busch-axcent® and future® linear.		
	Can be mounted freely in the room with the enclosed adhesive tape and fixing plate.		
	Including fixing plate for mounting on smooth walls or on switch boxes.		
	<b>6716 U-500</b>	2CKA006710A0014	1
	<b>Rocker</b>		
	For Friends of Hue smart switch insert 6716 U-500.		
	Combinable with the Busch-Jaeger switch ranges carat®, Busch-dynasty®, pure stainless steel, solo®, Busch-axcent® and future® linear.		
anthracite	<b>6736 FoH-81</b>	2CKA006730A0133	1
aluminium silver <sup>1)</sup>	<b>6736 FoH-83</b>	2CKA006730A0135	1
studio white	<b>6736 FoH-84</b>	2CKA006730A0136	1
grey metallic <sup>1)</sup>	<b>6736 FoH-803</b>	2CKA006730A0137	1
studio white, matt <sup>1)</sup>	<b>6736 FoH-884</b>	2CKA006730A0140	1
black matt <sup>1)</sup>	<b>6736 FoH-885</b>	2CKA006730A0141	1

<sup>1)</sup> Surface painted.

Product	Article-No.	Order-No.	Pack/Qty
	<b>Busch-rotary dimmer <sup>1)</sup> <sup>2)</sup> <sup>3)</sup> <sup>4)</sup> <sup>5)</sup> <sup>6)</sup> <sup>7)</sup> <sup>8)</sup> <sup>9)</sup> Flush-mounted, LED, 2-100 W</b>		
	With rotary control, two-way switch and soft-catch.		
	2-wire connection (neutral conductor not required)		
	Optimised for dimming of retrofit LED lamps (LEDi).		
	For dimmable Retrofit-LEDs (LEDi).		
	For dimmable Retrofit-LEDs (LEDi) with conventional or electronic transformers.		
	For incandescent lamps, 230 V tungsten halogen lamps, low-voltage halogen lamps with conventional or electronic transformers and dimmable energy-saving halogen lamps.		
	Mix operation of LEDi with conventional loads possible.		
	Via mode switch adjustable between leading edge control and trailing edge control.		
	Low-noise level by MOSFET transistors.		
	With electronic short-circuit protection.		
	With electronic overload protection.		
	With adjustable minimum brightness.		
	Without cover plate.		
	Rated voltage: 230 V~, + 10% / - 10%		
	Rated frequency: 50 Hz/60 Hz		
	Nominal power: 2 - 100 W/VA (retrofit LED loads).		
	Nominal power: 10 - 250 W/VA (non-LED loads).		
	Protection class (Device): IP 20		
	Temperature range (Device): 0 °C to 35 °C IEC 60669-2-1, British Standard EN 60669-2-1		
	    		
	<b>6523 U-102-500</b>	2CKA006512A0335	1/10

<sup>1)</sup> Illuminable with neon lamp. Neon lamp included in delivery with cover plate.

<sup>2)</sup> In the case of conventional transformers, take ~20% transformer loss into account.

<sup>3)</sup> In case of electronic transformers, 5 % transformer losses.

<sup>4)</sup> Also applicable for 1gang 2way installations.

<sup>5)</sup> Provided with terminal for net disconnection devices.

<sup>6)</sup> Only in conjunction with standard flush-mounting boxes according to DIN 49073, erect or Busch-Jaeger No. 3040 wallbox stonework, 3050 wallbox cavity wall or 3060 wallbox concrete)

<sup>7)</sup> Recommendation: Please use loads and types of one producer.

<sup>8)</sup> The dimmer interface is not standardised, it is the responsibility of the lamp manufacturers to list compatible products in their manufacturing information. Different installation situations can lead to different results. To clear up the problem, for example, it is recommended to carry out a local test of the selected lamps and dimmers. Please consult the lamp manufacturer for the LED dimmer recommended.



<sup>9)</sup> A liability on the part of Busch-Jaeger for the compatibility of the allocated lamps and dimmers is therefore excluded.

## Busch-axcent®

### Dimmers

Product	Article-No.	Order-No.	Pack/Qty
 <p><b>Busch-rotary dimmer</b> <sup>1) 2) 3) 4) 5) 7) 8) 9)</sup>  <b>UP, LED, 2-400 W</b>            Very small installation depth: &lt; 20 mm            Without claws.            With rotary control, two-way switch and soft-catch.            2-wire connection (neutral conductor not required)            Optimised for dimming of retrofit LED lamps (LEDi).            For dimmable Retrofit-LEDs (LEDi).            For dimmable Retrofit-LEDs (LEDi) with conventional or electronic transformers.            For incandescent lamps, 230 V tungsten halogen lamps, low-voltage halogen lamps with conventional or electronic transformers and dimmable energy-saving halogen lamps.            Mix operator of LEDi with conventional loads possible.            With manually adjustable operating mode: trailing / leading edge control.            With adjustable minimum/maximum brightness.            Low-noise level by MOSFET transistors.            With electronic short-circuit protection.            With electronic overload protection.            Without cover plate.            Rated voltage: 230 V~, + 10% / - 10%            Rated frequency: 50 Hz/60 Hz            Nominal power: 2 - 100 W/VA (leading edge control)            Nominal power: 2 - 400 W/VA (trailing edge control)            Protection class (Device): IP 20            Temperature range (Device): 0 °C to 35 °C IEC 60669-2-1, British Standard EN 60669-2-1</p> 	<b>6523 UR-103-500</b>	<b>2CKA006512A0345</b>	<b>1/10</b>

- <sup>1)</sup> Illuminable with neon lamp. Neon lamp included in delivery with cover plate.  
<sup>2)</sup> In the case of conventional transformers, take ~20% transformer loss into account.  
<sup>3)</sup> In case of electronic transformers, 5 % transformer losses.  
<sup>4)</sup> Also applicable for 1gang 2way installations.  
<sup>5)</sup> Provided with terminal for net disconnection devices.  
<sup>6)</sup> Only in conjunction with standard flush-mounting boxes according to DIN 49073, erect or Busch-Jaeger No. 3040 wallbox stonework, 3050 wallbox cavity wall or 3060 wallbox concrete)  
<sup>7)</sup> Recommendation: Please use loads and types of one producer.  
<sup>8)</sup> The dimmer interface is not standardised, it is the responsibility of the lamp manufacturers to list compatible products in their manufacturing information. Different installation situations can lead to different results. To clear up the problem, for example, it is recommended to carry out a local test of the selected lamps and dimmers. Please consult the lamp manufacturer for the LED dimmer recommended.  
<sup>9)</sup> A liability on the part of Busch-Jaeger for the compatibility of the allocated lamps and dimmers is therefore excluded.

Product	Article-No.	Order-No.	Pack/Qty
 <p><b>Busch-touch dimmer</b> <sup>1) 2) 3) 4) 5) 7) 8) 9)</sup>  <b>Flush-mounted, LED, 2-100 W</b>            Touch dimmer.            2-wire connection (neutral conductor not required)            Neutral conductor optionally connectable (recommended for the connection of low loads &lt; 10 W/VA).            Optimised for dimming of retrofit LED lamps (LEDi).            For incandescent lamps, 230V tungsten halogen lamps and low-voltage halogen lamps with conventional transformers or electronic transformers and dimmable halogen energy-saving lamps.            Mix operator of LEDi with conventional loads possible.            With adjustable minimum brightness.            The minimum brightness for the leading edge control can be adjusted using the potentiometer.            The potentiometer at the left limit stop corresponds with the trailing edge control mode.            Low-noise level by MOSFET transistors.            With electronic short-circuit protection.            With electronic overload protection.            With light-level memory and minimum brightness memory.            Operation also possible via conventional push buttons (2020 US, 2021/6 UK).            Without control cover.            For control cover with control lamp 6543-xxx-10x.            For Busch-Remote control IR control cover 6066-xxx-10x.            For comfort timer control element 6455-101-500.            For Busch-Watchdog Presence tech 6813-xxx-101 und 6813/11-xxx.            Nominal power: 2 - 100 W/VA (retrofit LED loads).            Nominal power: 10 - 200 W/VA (non-LED loads).            Rated voltage: 230 V~, +10 % / -10 %            Rated frequency: 50 Hz - 60 Hz            Inputs: 1            Outputs: 1x dimming channel            Protection class (Device): IP 20            Temperature range (Device): 0 °C to 35 °C            Dimensions: (L x W x D): 71 mm x 71 mm x 32 mm IEC 60669-2-1, British Standard EN 60669-2-1</p> 	<b>6526 U-500</b>	<b>2CKA006512A0323</b>	<b>1/10</b>

- <sup>1)</sup> Illuminable with neon lamp. Neon lamp included in delivery with cover plate.  
<sup>2)</sup> In the case of conventional transformers, take ~20% transformer loss into account.  
<sup>3)</sup> In case of electronic transformers, 5 % transformer losses.  
<sup>4)</sup> Only in conjunction with standard flush-mounting boxes according to DIN 49073, erect or Busch-Jaeger No. 3040 wallbox stonework, 3050 wallbox cavity wall or 3060 wallbox concrete)  
<sup>5)</sup> Recommendation: Please use loads and types of one producer.  
<sup>6)</sup> In connection with 6810-21x-101 and 6800-xx-104 (M) only suitable for switching retrofit LEDs (for 2-conductor connection).  
<sup>7)</sup> The dimmer interface is not standardised, it is the responsibility of the lamp manufacturers to list compatible products in their manufacturing information. Different installation situations can lead to different results. To clear up the problem, for example, it is recommended to carry out a local test of the selected lamps and dimmers. Please consult the lamp manufacturer for the LED dimmer recommended.  
<sup>8)</sup> A liability on the part of Busch-Jaeger for the compatibility of the allocated lamps and dimmers is therefore excluded.

# Busch-axcent®

## Dimmers

Product	Article-No.	Order-No.	Pack/Qty
---------	-------------	-----------	----------



**Busch-rotary dimmer <sup>1)</sup> <sup>2)</sup> <sup>3)</sup> <sup>4)</sup>  
flush mounted, R, 60-600 W**  
With rotary control, 2way On-Off switching and soft-catch.  
Leading Edge control.  
For incandescent lamps and 230 V tungsten halogen lamps.  
With adjustable minimum brightness.  
Without cover plate.  
Rated voltage: 230 V~, +10 % / -10 %  
Rated frequency: 50 Hz  
Rated power: 60 - 600 W  
IEC 60669-2-1, British Standard EN 60669-2-1



<b>2250 U-500</b>	2CKA006515A0848	1/10
-------------------	-----------------	------

<sup>1)</sup> Illuminable with neon lamp. Neon lamp included in delivery with cover plate.

<sup>2)</sup> Also applicable for 1gang 2way installations.

<sup>3)</sup> Only in conjunction with standard flush-mounting boxes according to DIN 49073, erect or Busch-Jaeger No. 3040 wallbox stonework, 3050 wallbox cavity wall or 3060 wallbox concrete)

<sup>4)</sup> Provided with terminal for net disconnection devices.



**Busch-rotary dimmer <sup>1)</sup> <sup>2)</sup> <sup>3)</sup> <sup>4)</sup> <sup>5)</sup>  
flush mounted, RL, 20-500 W**  
With rotary control, 2way On-Off switching and soft-catch.  
Leading Edge control.  
For incandescent lamps, 230 V tungsten halogen lamps and low-volt halogen lamps with conventional transformer.  
With adjustable minimum brightness.  
Without cover plate.  
Rated voltage: 230 V~, +10 % / -10 %  
Rated frequency: 50 Hz  
Rated power: 20 - 500 W/VA  
IEC 60669-2-1, British Standard EN 60669-2-1

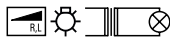

<b>2247 U-500</b>	2CKA006512A0302	1/10
-------------------	-----------------	------

<sup>1)</sup> Illuminable with neon lamp. Neon lamp included in delivery with cover plate.

<sup>2)</sup> In the case of conventional transformers, take ~20% transformer loss into account.

<sup>3)</sup> Provided with terminal for net disconnection devices.

<sup>4)</sup> Also applicable for 1gang 2way installations.

<sup>5)</sup> Only in conjunction with standard flush-mounting boxes according to DIN 49073, erect or Busch-Jaeger No. 3040 wallbox stonework, 3050 wallbox cavity wall or 3060 wallbox concrete)

Product	Article-No.	Order-No.	Pack/Qty
---------	-------------	-----------	----------



**Busch-rotary dimmer <sup>1)</sup> <sup>2)</sup> <sup>3)</sup> <sup>4)</sup> <sup>5)</sup> <sup>6)</sup>  
UP, RL, 200-700 W**  
With rotary control, 2way On-Off switching and soft-catch.  
Leading Edge control.  
For incandescent lamps, 230 V tungsten halogen lamps and low-volt halogen lamps with conventional transformer.  
Short-circuit-proof, overload-protected.  
With adjustable minimum brightness.  
Without cover plate.  
Without claws.  
Rated voltage: 230 V~, +10 % / -10 %  
Rated frequency: 50 Hz  
Rated power: 200 - 700 W/VA  
IEC 60669-2-1, British Standard EN 60669-2-1

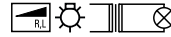

<b>6520 U-500</b>	2CKA006520A0227	1/10
-------------------	-----------------	------

<sup>1)</sup> Illuminable with neon lamp. Neon lamp included in delivery with cover plate.

<sup>2)</sup> In the case of conventional transformers, take ~20% transformer loss into account.

<sup>3)</sup> Provided with terminal for net disconnection devices.

<sup>4)</sup> Also applicable for 1gang 2way installations.

<sup>5)</sup> Only in conjunction with standard flush-mounting boxes according to DIN 49073, erect or Busch-Jaeger No. 3040 wallbox stonework, 3050 wallbox cavity wall or 3060 wallbox concrete)

<sup>6)</sup> Should be mounted in a separate wallbox.



**Busch-rotary dimmer <sup>1)</sup> <sup>2)</sup> <sup>3)</sup> <sup>4)</sup> <sup>5)</sup> <sup>6)</sup>  
flush mounted, RC, 40-420 W**  
With rotary control, soft-catch and with trailing edge control.  
For incandescent lamps, 230 V tungsten halogen lamps and low-voltage halogen lamps with electronic transformers.  
Low-noise, short-circuit-proof, overload-protected.  
Without cover plate.  
Rated voltage: 230 V~, +10 % / -10 %  
Rated frequency: 50 Hz  
Rated power: 40 - 420 W/VA  
IEC 60669-2-1, British Standard EN 60669-2-1



<b>6513 U-102-500</b>	2CKA006513A0586	1/10
-----------------------	-----------------	------

<sup>1)</sup> Not suitable with conventional transformers.

<sup>2)</sup> Illuminable with neon lamp. Neon lamp included in delivery with cover plate.

<sup>3)</sup> In case of electronic transformers, 5 % transformer losses.

<sup>4)</sup> Provided with terminal for net disconnection devices.

<sup>5)</sup> Also applicable for 1gang 2way installations.

<sup>6)</sup> Only in conjunction with standard flush-mounting boxes according to DIN 49073, erect or Busch-Jaeger No. 3040 wallbox stonework, 3050 wallbox cavity wall or 3060 wallbox concrete)

# Busch-axcent®

## Dimmers

Product	Article-No.	Order-No.	Pack/Qty
---------	-------------	-----------	----------



**Busch-rotary dimmer** <sup>1)</sup> <sup>2)</sup> <sup>3)</sup> <sup>4)</sup> <sup>5)</sup>  
**flush mounted, RC, 40-420 W**  
 DP switched  
 With rotary control, soft-catch and with trailing edge control.  
 For incandescent lamps, 230 V tungsten halogen lamps and low-voltage halogen lamps with electronic transformers.  
 Low-noise, short-circuit-proof, overload-protected.  
 Without cover plate.  
 DP cut off (P,N)  
 Rated voltage: 230 V~, +10 % / -10 %  
 Rated frequency: 50 Hz  
 Rated power: 20 - 420 W/VA  
 IEC 60669-2-1, British Standard EN 60669-2-1

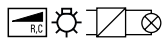

**6514 U-500** 2CKA006514A0115 1

- <sup>1)</sup> Not suitable with conventional transformers.  
<sup>2)</sup> Illuminable with neon lamp. Neon lamp included in delivery with cover plate.  
<sup>3)</sup> In case of electronic transformers, 5 % transformer losses.  
<sup>4)</sup> Provided with terminal for net disconnection devices.  
<sup>5)</sup> Also applicable for 1gang 2way installations.  
<sup>6)</sup> Only in conjunction with standard flush-mounting boxes according to DIN 49073, erect or Busch-Jaeger No. 3040 wallbox stonework, 3050 wallbox cavity wall or 3060 wallbox concrete)



**Busch-rotary dimmer** <sup>1)</sup> <sup>2)</sup> <sup>3)</sup> <sup>4)</sup> <sup>5)</sup>  
**flush mounted, RLC, 60-420 W**  
 with soft-catch  
 With intelligence for universal operation.  
 For incandescent lamps, 230 V tungsten halogen lamps and low-voltage halogen lamps with conventional transformers or electronic transformers.  
 Short-circuit-proof, overload-protected.  
 Capacity expansion via output-side, parallel connectable load line with a power module 6594 U up to 735 W/VA possible. Operation via rotary-type remote control 6592 U possible, Without cover plate.  
 Rated voltage: 230 V~, +10 % / -10 %  
 Rated frequency: 50 Hz - 60 Hz  
 Rated power: 60 - 420 W/VA  
 IEC 60669-2-1, British Standard EN 60669-2-1



**6591 U-101-500** 2CKA006513A0588 1/10

- <sup>1)</sup> Illuminable with neon lamp 3855. Neon lamp included in delivery with cover plate.  
<sup>2)</sup> In case of electronic transformers, 5 % transformer losses.  
<sup>3)</sup> In the case of conventional transformers, take ~20% transformer loss into account.  
<sup>4)</sup> Only in conjunction with standard flush-mounting boxes according to DIN 49073, erect or Busch-Jaeger No. 3040 wallbox stonework, 3050 wallbox cavity wall or 3060 wallbox concrete)  
<sup>5)</sup> Cannot be combined with a 2way switch.



**Busch-rotary dimmer, extension** <sup>1)</sup> <sup>2)</sup>  
**flush mounted**  
 for connection to 6591 U-101,  
 To be used with Busch-Dimmer®, MDRC 6583.  
 with soft-catch  
 A maximum of 5 multi-way extensions can be connected to a 6591U-101,  
 Without cover plate.  
 Rated voltage: 230 V~, +10 % / -10 %  
 Rated frequency: 50 Hz - 60 Hz



**6592 U-500** 2CKA006513A0590 1

- <sup>1)</sup> Control elements 2115-xxx and 6540-xxx.  
<sup>2)</sup> Required for illuminating the N-connection control element.

Product	Article-No.	Order-No.	Pack/Qty
---------	-------------	-----------	----------



**Busch-rotary dimmer** <sup>1)</sup> <sup>2)</sup> <sup>3)</sup> <sup>4)</sup>  
**flush mounted, 1-10V**  
 With rotary control.  
 For controlling ballast units for fluorescent lamps with control output 1-10 V DC, control current max. 50 mA DC.  
 For LED control via control gears  
 Without cover plate.  
 Rated voltage: 230 V~, +10 % / -10 %  
 Rated frequency: 50 Hz - 60 Hz  
 Rated power: 700 W/VA  
 IEC 60669-2-1, British Standard EN 60669-2-1



**2112 U-101-500** 2CKA006599A2873 1/10

- <sup>1)</sup> Non-illuminable.  
<sup>2)</sup> Use cover plates 2115 J-.../2115-.../6540-...  
<sup>3)</sup> Only in conjunction with standard flush-mounting boxes according to DIN 49073, erect or Busch-Jaeger No. 3040 wallbox stonework, 3050 wallbox cavity wall or 3060 wallbox concrete)  
<sup>4)</sup> Making-current limiters have to be provided in case of too high making currents.



**Busch-rotary dimmer** <sup>1)</sup>  
**Flush-mounted, DALI, tunable white**  
 For DALI broadcast service (via central telegram).  
 For switching and dimming up to 64 DALI- devices like electronic ballasts and transformers with DALI-interface.  
 With rotary control and ON/OFF push operation.  
 Fool proof.  
 For changing the colour temperature of >tunable white< lamps, which meet DALI Standard IEC 62386-209 (Device Type 8).  
 Colour temperature can then be set between 2,700 K - 6,500 K.  
 Brightness power-on level and background brightness level adjustable, buffered.  
 With integrated LED illumination for orientation.  
 Color of orientation light adjustable (18 presets and OFF).  
 Up to 5 potentiometers are connectable in parallel.  
 Max. current consumption: 15 mA.  
 Not suitable for combining with other DALI sensors or central units of other manufacturers.  
 For the generation of the DALI voltage a power supply according to IEC 62386 is required; e.g. from Tridonic, Philips, Helvar or BJE article no. 2116/11 U.  
 Max. DALI-cable length: 300 m (1,5 - 2,5 mm<sup>2</sup>).  
 Without cover plate.  
 Protection class (Device): IP 20  
 Temperature range (Device): 0 °C to 35 °C

**2116 U** 2CKA006599A3025 1

- <sup>1)</sup> Only in conjunction with standard flush-mounting boxes according to DIN 49073, erect or Busch-Jaeger No. 3040 wallbox stonework, 3050 wallbox cavity wall or 3060 wallbox concrete)

# Busch-axcent®

## Dimmers

Product	Article-No.	Order-No.	Pack/Qty
 <p><b>Busch-rotary dimmer <sup>1)</sup></b>  <b>Flush-mounted, DALI, with internal power supply, tunable white</b>            For DALI broadcast service (via central telegram).            With integrated DALI power adaptor.            For switching and dimming up to 64 DALI- devices like electronic ballasts and transformers with DALI-interface.            With rotary control and ON/OFF push operation.            For changing the colour temperature of &gt;tunable white&lt; lamps, which meet DALI Standard IEC 62386-209 (Device Type 8).            Colour temperature can then be set between 2,700 K - 6,500 K.            With electronic short-circuit protection.            With electronic overload protection.            Brightness power-on level and background brightness level adjustable, buffered.            With integrated LED illumination for orientation.            Color of orientation light adjustable (18 presets and OFF).            Up to 5 potentiometers are connectable in parallel.            Up to 3 potentiometers are connectable in parallel in active mode.            Not suitable for combining with other DALI sensors or central units of other manufacturers.            DALI-voltage: 15,5 V=            Rated current: max. 75 mA            Power consumption: &lt; 2,5 W            Number of DALI-units:            37 in case of one active power-potentiometer            in case of three active power-potentiometer in parallel connection: 111            Active mode: the potentiometer is supporting the necessary control circuit for other DALI-devices.            Passive mode: the potentiometer is suitable as additional operation point.            Max. DALI-cable length: 300 m (1,5 - 2,5 mm<sup>2</sup>).            Without cover plate.            Rated voltage: 230 V~, +10 % / -10 %            Rated frequency: 50 Hz - 60 Hz            Protection class (Device): IP 20            Temperature range (Device): 0 °C to 35 °C</p>	<b>2116/11 U</b>	2CKA006599A3026	1

<sup>1)</sup> Only in conjunction with standard flush-mounting boxes according to DIN 49073, erect or Busch-Jaeger No. 3040 wallbox stonework, 3050 wallbox cavity wall or 3060 wallbox concrete)

Product	Article-No.	Order-No.	Pack/Qty
 <p><b>Busch-rotary dimmer <sup>1)</sup></b>  <b>flush mounted, DALI</b>            For DALI broadcast service (via central telegram).            For switching and dimming up to 64 DALI- devices like electronic ballasts and transformers with DALI-interface.            With rotary control and ON/OFF push operation.            Fool proved.            Brightness power-on level and background brightness level adjustable, buffered.            With integrated LED illumination for orientation.            Color of orientation light adjustable (18 presets and OFF).            Up to 5 potentiometers are connectable in parallel.            Max. current consumption: 15 mA.            Not suitable for combining with other DALI sensors or central units of other manufacturers.            An additional DALI power supply is needed, e.g. by Tridonic, Philips, Helvar or 2117/11 U.            Max. DALI-cable length: 300 m (1,5 - 2,5 mm<sup>2</sup>).            Without cover plate.            Protection class (Device): IP 20            Temperature range (Device): 0 °C to 35 °C</p>	<b>2117 U-500</b>	2CKA006599A2987	1

<sup>1)</sup> Only in conjunction with standard flush-mounting boxes according to DIN 49073, erect or Busch-Jaeger No. 3040 wallbox stonework, 3050 wallbox cavity wall or 3060 wallbox concrete)

 <p><b>Busch-rotary dimmer <sup>1)</sup></b>  <b>flush mounted, DALI, with internal power supply</b>            For DALI broadcast service (via central telegram).            With integrated DALI power adaptor.            For switching and dimming up to 64 DALI- devices like electronic ballasts and transformers with DALI-interface.            With rotary control and ON/OFF push operation.            With electronic short-circuit protection.            With electronic overload protection.            Brightness power-on level and background brightness level adjustable, buffered.            With integrated LED illumination for orientation.            Color of orientation light adjustable (18 presets and OFF).            Up to 5 potentiometers are connectable in parallel.            Up to 3 potentiometers are connectable in parallel in active mode.            Not suitable for combining with other DALI sensors or central units of other manufacturers.            DALI-voltage: 15,5 V=            Rated current: max. 75 mA            Power consumption: &lt; 2,5 W            Number of DALI-units:            37 in case of one active power-potentiometer            in case of three active power-potentiometer in parallel connection: 111            Active mode: the potentiometer is supporting the necessary control circuit for other DALI-devices.            Passive mode: the potentiometer is suitable as additional operation point.            Max. DALI-cable length: 300 m (1,5 - 2,5 mm<sup>2</sup>).            Without cover plate.            Rated voltage: 230 V~, +10 % / -10 %            Rated frequency: 50 Hz - 60 Hz            Protection class (Device): IP 20            Temperature range (Device): 0 °C to 35 °C</p>	<b>2117/11 U-500</b>	2CKA006599A2988	1
--	----------------------	-----------------	---

<sup>1)</sup> Only in conjunction with standard flush-mounting boxes according to DIN 49073, erect or Busch-Jaeger No. 3040 wallbox stonework, 3050 wallbox cavity wall or 3060 wallbox concrete)

## Busch-axcent®

### Dimmers

Product	Article-No.	Order-No.	Pack/Qty
---------	-------------	-----------	----------



#### Busch-touch dimmer 1) 2)

##### flush mounted, RL, 25-500 W

With light-level memory and leading edge control.  
For incandescent lamps, 230 V tungsten halogen lamps and low-volt halogen lamps with conventional transformer.  
Compatible with control covers 6543-xxx-10x.  
Operation also possible via conventional push buttons (2020 US, 2021/6 UK).  
Parallel operation of several transformers and/or incandescents lamps possible.  
Without control cover.  
Rated voltage: 230 V~, +10 % / -10 %  
Rated frequency: 50 Hz - 60 Hz  
Rated power: 25 - 500 W/VA  
IEC 60669-2-1, British Standard EN 60669-2-1

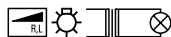

**6560 U-101-500**      2CKA006560A1207      1/10

<sup>1)</sup>In the case of conventional transformers, take ~20% transformer loss into account.

<sup>2)</sup>Only in conjunction with standard flush-mounting boxes according to DIN 49073, erect or Busch-Jaeger No. 3040 wallbox stonework, 3050 wallbox cavity wall or 3060 wallbox concrete)



#### Busch touch-dimmer range 1) 2) 3) 4)

##### flush mounted, RC, 45-315 W

For switching and dimming 2 independent devices.  
With trailing edge control.  
2gang 1way  
For incandescent lamps, 230 V tungsten halogen lamps and low-voltage halogen lamps with electronic transformers.  
Compatible with control covers 6545-xxx.  
Without cover, without cover plate.  
Outputs: 2 independent dimmer channels.  
Rated power: 40-315 W/VA per channel.  
Rated voltage: 230 V~, +10 % / -10 %  
Rated frequency: 50 Hz - 60 Hz IEC 60669-2-1, British Standard EN 60669-2-1



**6565 U-500**      2CKA006565A0057      1/10

<sup>1)</sup>Not suitable with conventional transformers.

<sup>2)</sup>In case of electronic transformers, 5 % transformer losses.

<sup>3)</sup>Only in conjunction with standard flush-mounting boxes according to DIN 49073, erect or Busch-Jaeger No. 3040 wallbox stonework, 3050 wallbox cavity wall or 3060 wallbox concrete)

<sup>4)</sup>Does not provide an extension input.

Product	Article-No.	Order-No.	Pack/Qty
---------	-------------	-----------	----------



#### Busch-touch dimmer 1) 2) 3) 4)

##### flush mounted, RLC, 60-420 W

With light-level memory and intelligence for universal operation.  
Selectable Soft-ON/OFF function and memory function.  
Capacity expansion via output-side, parallel connectable load line with a power module 6594 U up to 735 W/VA possible.  
For incandescent lamps, 230 V tungsten halogen lamps and low-voltage halogen lamps with conventional transformers or electronic transformers.  
Short-circuit-proof, overload-protected.  
With touch control.  
Operation also possible via conventional push buttons (2020 US, 2021/6 UK).  
Without control cover.

For control cover with control lamp 6543-xxx-10x.  
For Busch-Remote control IR control cover 6066-xxx-10x.  
For comfort timer control element 6455-101-500.  
For Busch-Watchdog 180 flush-mounted Sensor Standard 6810-21x-101.

For Busch-Watchdog 180 flush-mounted sensor Comfort II 6800-xxx-104 and 6800-xxx-104M.  
For Busch-Watchdog Presence tech 6813-xxx-101 und 6813/11-xxx.

Combinable with Busch-Watchdog extension insert 6805 U.

Rated voltage: 230 V~, +10 % / -10 %  
Rated frequency: 50 Hz  
Rated power: 60 - 420 W  
Rated power: 60 - 420 W/VA  
IEC 60669-2-1, British Standard EN 60669-2-1



**6593 U-500**      2CKA006590A0171      1/10

<sup>1)</sup>In the case of conventional transformers, take ~20% transformer loss into account.

<sup>2)</sup>In case of electronic transformers, 5 % transformer losses.

<sup>3)</sup>In conjunction with 6800-xxx-104 (M) a Soft Off can be adjusted.

<sup>4)</sup>Only in conjunction with standard flush-mounting boxes according to DIN 49073, erect or Busch-Jaeger No. 3040 wallbox stonework, 3050 wallbox cavity wall or 3060 wallbox concrete)



#### Busch-Dimmer®, capacity booster 1)

##### flush mounted, RLC, 200-315 W

The control is effected by a Busch-Universal master dimmer 6593 U or Busch-Universal rotary dimmer 6591U-101

For incandescent lamps, 230 V tungsten halogen lamps and low-voltage halogen lamps with conventional transformers or electronic transformers.

Can only be installed in conjunction with a cover plate 2114-xxx and 6541-xxx.

Without cover plate.

Rated voltage: 230 V~, +10 % / -10 %  
Rated frequency: 50 Hz  
Rated power: 200 - 315 W/VA

IEC 60669-2-1, British Standard EN 60669-2-1



**6594 U-500**      2CKA006590A0172      1

<sup>1)</sup>Only in conjunction with standard flush-mounting boxes according to DIN 49073, erect or Busch-Jaeger No. 3040 wallbox stonework, 3050 wallbox cavity wall or 3060 wallbox concrete)

# Busch-axcent®

## Dimmers

Product	Article-No.	Order-No.	Pack/Qty
	<b>Cover plate <sup>1)</sup> with rotary knob, with indication lamp</b> Elevated knob. With transparent luminous ring. For Busch-Dimmer®. For inserts 2112 U-101/2247 U/2250 U/6513 U-102/6517 U-10x/ 6519 U/6520 U/6523 U(R)(10x) /6591 U-10x and 6592 U.		
anthracite	<b>6540-81-102</b>	2CKA006599A2950	10
aluminium silver <sup>2)</sup>	<b>6540-83-102</b>	2CKA006599A2952	10/100
studio white	<b>6540-84-102-500</b>	2CKA006599A3009	10/100
grey metallic <sup>2)</sup>	<b>6540-803-102</b>	2CKA006599A2980	10
studio white, matt <sup>2)</sup>	<b>6540-884-102</b>	2CKA006599A2961	10/100
black matt <sup>2)</sup>	<b>6540-885-102</b>	2CKA006599A2966	10/100

<sup>1)</sup> Replacement neon lamp, Art. No. 3855.

<sup>2)</sup> Surface painted.

	<b>Control element <sup>1)</sup> <sup>2)</sup> <sup>3)</sup> with neon lamp</b> Can be combined with LED dimmer 6524 U, and 6526 U, Busch-Universal touch-type controller 6550 U-10x, Busch-Memory touch dimmer 6560 U-101, Busch-Universal-Dimmer® 6593 U, Busch-Universal relay insert 6401 U-10x, Busch-Universal 2gang insert 6402 U.		
anthracite	<b>6543-81-101</b>	2CKA006599A2881	1/10
aluminium silver <sup>4)</sup>	<b>6543-83-101</b>	2CKA006599A2887	1/10
studio white	<b>6543-84-101-500</b>	2CKA006599A3010	1/10
grey metallic <sup>4)</sup>	<b>6543-803-101</b>	2CKA006599A2942	1/10
studio white, matt <sup>4)</sup>	<b>6543-884-101</b>	2CKA006599A2963	1/10
black matt <sup>4)</sup>	<b>6543-885-101</b>	2CKA006599A2968	1/10

<sup>1)</sup> Compatible with previous type 6543-xxx.

<sup>2)</sup> Touch-type Controller 6550 U-xxx non-illuminable.

<sup>3)</sup> Replacement neon lamp 3857.

<sup>4)</sup> Surface painted.

	<b>Control element <sup>1)</sup> with neon lamp</b> Combinable with Busch-Memory 2gang dimmer 6565 U.		
anthracite	<b>6545-81</b>	2CKA006599A2906	1/10
aluminium silver <sup>2)</sup>	<b>6545-83</b>	2CKA006599A2914	1/10
studio white	<b>6545-84</b>	2CKA006599A2908	1/10
grey metallic <sup>2)</sup>	<b>6545-803</b>	2CKA006599A2943	1/10
studio white, matt <sup>2)</sup>	<b>6545-884</b>	2CKA006599A2964	1/10
black matt <sup>2)</sup>	<b>6545-885</b>	2CKA006599A2969	1/10

<sup>1)</sup> Replacement neon lamp 3857.

<sup>2)</sup> Surface painted.

Product	Article-No.	Order-No.	Pack/Qty
	<b>Cover plate for cooling element</b> For Busch-Universal master dimmer power module 6594 U. For KNX room temperature controller object 6109/08.		
anthracite	<b>6541-81</b>	2CKA006599A2882	10
aluminium silver <sup>1)</sup>	<b>6541-83</b>	2CKA006599A2885	10
studio white	<b>6541-84</b>	2CKA006599A2835	10
grey metallic <sup>1)</sup>	<b>6541-803</b>	2CKA006599A2940	10
studio white, matt <sup>1)</sup>	<b>6541-884</b>	2CKA006599A2962	10
black matt <sup>1)</sup>	<b>6541-885</b>	2CKA006599A2967	10

<sup>1)</sup> Surface painted.



## Busch-axcent®

### Movement detectors

Product	Article-No.	Order-No.	Pack/Qty
---------	-------------	-----------	----------



#### Proximity switch

3 wire connection (neutral conductor required).  
Relay insert with proximity sensor.  
For contactless ON/OFF switching of electric loads, e.g. lights.  
For switching incandescent lamps, 230 V tungsten halogen lamps, fluorescent lamps and low-voltage halogen lamps, that are actuated via transformers.  
Switches when detecting an approach at < approx. 5 cm.  
Operation also possible via conventional push buttons (2020 US, 2021/6 UK).  
Rated voltage: 230 V~, +10 % / -10 %  
Rated frequency: 50 Hz - 60 Hz  
Outputs: 1x Normally open contact, potential-bound  
Suitable for: 230 V incandescent lamps, 230 V halogen lamps, fluorescent lamps and low-voltage halogen lamps, that are operated via transformers.  
Rated current: 10 AX  
Rated power: 2300 W/VA  
Temperature range (Device): -25 °C to 55 °C  
British Standard EN 60669-2-1

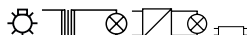

<b>6406 U</b>	2CKA006400A0034	1
---------------	-----------------	---



#### Cover plate

#### Proximity switch

For proximity switch 6406 U.

Product	Article-No.	Order-No.	Pack/Qty
anthracite	<b>6476-81</b>	2CKA006470A0007	1/10
aluminium silver <sup>1)</sup>	<b>6476-83</b>	2CKA006470A0008	10
ivory white	<b>6476-82</b>	2CKA006470A0003	10
studio white	<b>6476-84</b>	2CKA006470A0004	10
grey metallic <sup>1)</sup>	<b>6476-803</b>	2CKA006470A0006	10
studio white, matt <sup>1)</sup>	<b>6476-884</b>	2CKA006470A0010	10
black matt <sup>1)</sup>	<b>6476-885</b>	2CKA006470A0011	10

<sup>1)</sup>Surface painted.

Product	Article-No.	Order-No.	Pack/Qty
---------	-------------	-----------	----------



#### Relay insert flex, 1gang <sup>1)</sup>

3 wire connection (neutral conductor required).  
For switching lighting systems.  
Operation in 1gang 2way installations via push switch-unit for combination with flush-mounted units.  
Operation also possible via conventional push buttons (2020 US, 2021/6 UK).  
Without control cover.  
For control element flex, 1gang, wireless, 62711-WL.  
For control element flex, 2gang, wireless, 62721-WL.  
For Busch-Comfort switch flex control element 64765-... .  
For Busch-Watchdog 180 flex sensors 6476x-... .  
For Busch-Watchdog 180 flex sensors, wireless, 6276x-...-WL.  
Combinable with extension insert, 64891 U.  
Rated voltage: 230 V~, +10 % / -10 %  
Rated frequency: 50 Hz  
Inputs: 1  
Outputs: 1x Normally open contact, potential-bound  
Suitable for: 230 V- LEDi, typical.  
Rated power: 300 VA  
Suitable for: 230 V incandescent lamps/230 V halogen lamps  
Rated power: 2300 W  
Suitable for: Low voltage halogen lamps that are operated via transformers.  
Rated power: 2300 VA  
Temperature range (Device): -25 °C to 55 °C  
Dimensions: (L x W x D): 71 mm x 71 mm x 30 mm  
Mounting depth: 25 mm

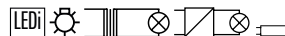

<b>64811 U-500</b>	2CKA006800A3042	1/10
--------------------	-----------------	------



<sup>1)</sup>Only in conjunction with standard flush-mounting boxes according to DIN 49073, erect or Busch-Jaeger No. 3040 wallbox stonework, 3050 wallbox cavity wall or 3060 wallbox concrete)

## Busch-axcent®

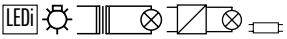
### Movement detectors

Product	Article-No.	Order-No.	Pack/Qty
 <p><b>Relay insert flex, 2gang <sup>1)</sup></b>            3 wire connection (neutral conductor required).            For switching lighting systems.            For switching two independent load circuits.            For controlling light and ventilation systems.            Operation in 1gang 2way installations via push switch-unit for combination with flush-mounted units.            Operation also possible via conventional push buttons (2020 US, 2021/6 UK).            Without control cover.            For control element flex, 1gang, wireless, 62711-WL.            For control element flex, 2gang, wireless, 62721-WL.            For Busch-Comfort switch flex control element 64765-... .            For Busch-Watchdog 180 flex sensors 6476x-... .            For Busch-Watchdog 180 flex sensors, wireless, 6276x-...-WL.            Combinable with extension insert, 64891 U.            Rated voltage: 230 V~, +10 % / -10 %            Rated frequency: 50 Hz            Inputs: 2            Outputs: 2x Normally open contact, potential-bound            Suitable for: 230 V- LEDi, typical.            Rated power: 300 VA            Suitable for: 230 V incandescent lamps/230 V halogen lamps            Rated power: 1840 W            Suitable for: Low voltage halogen lamps that are operated via transformers.            Rated power: 1150 VA            Temperature range (Device): -25 °C to 55 °C            Dimensions: (L x W x D): 71 mm x 71 mm x 30 mm            Mounting depth: 25 mm</p> 	<b>64821 U-500</b>	2CKA006800A3045	1

<sup>1)</sup> Only in conjunction with standard flush-mounting boxes according to DIN 49073, erect or Busch-Jaeger No. 3040 wallbox stonework, 3050 wallbox cavity wall or 3060 wallbox concrete)

Product	Article-No.	Order-No.	Pack/Qty
 <p><b>e-contact insert flex, 1gang <sup>1) 2)</sup></b>            2-wire connection (neutral conductor not required)            Neutral conductor optionally connectable (recommended for the connection of low loads &lt; 10 W/VA).            For switching lighting systems.            Operation in 1gang 2way installations via push switch-unit for combination with flush-mounted units.            Operation also possible via conventional push buttons (2020 US, 2021/6 UK).            Without control cover.            For control element flex, 1gang, wireless, 62711-WL.            For control element flex, 2gang, wireless, 62721-WL.            For Busch-Watchdog 180 flex sensors 6476x-... .            For Busch-Watchdog 180 flex sensors, wireless, 6276x-...-WL.            Combinable with extension insert, 64891 U.            Rated voltage: 230 V~, +10 % / -10 %            Rated frequency: 50 Hz            Inputs: 1            Outputs: 1x Normally open contact, potential-bound            Suitable for: 230 V- LEDi, typical.            Rated power: 3 - 240 VA            Suitable for: 230 V incandescent lamps/230 V halogen lamps            Rated power: 10 - 240 W            Suitable for: Low voltage halogen lamps that are operated via transformers.            Rated power: 3 - 240 VA            Temperature range (Device): -5 °C to 45 °C            Dimensions: (L x W x D): 71 mm x 71 mm x 30 mm            Mounting depth: 25 mm</p> 	<b>64814 U-500</b>	2CKA006800A3048	1

<sup>1)</sup> Use only dimmable high-voltage LEDs.

<sup>2)</sup> Only in conjunction with standard flush-mounting boxes according to DIN 49073, erect or Busch-Jaeger No. 3040 wallbox stonework, 3050 wallbox cavity wall or 3060 wallbox concrete)

## Busch-axcent®

### Movement detectors

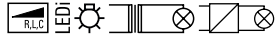
Product	Article-No.	Order-No.	Pack/Qty
 <p><b>LED dimmer insert flex, 1gang <sup>1)</sup> <sup>2)</sup> <sup>3)</sup> <sup>4)</sup> <sup>5)</sup> <sup>6)</sup> FM, LED, 3-240 VA</b> 2-wire connection (neutral conductor not required) Neutral conductor optionally connectable (recommended for the connection of low loads &lt; 10 W/VA). Touch dimmer for switching lighting systems. Operation in 1gang 2way installations via push switch- unit for combination with flush-mounted units. Operation also possible via conventional push buttons (2020 US, 2021/6 UK). Optimised for dimming of retrofit LED lamps (LEDi). For dimmable Retrofit-LEDs (LEDi). For dimmable Retrofit-LEDs (LEDi) with conventional or electronic transformers. For incandescent lamps, 230 V tungsten halogen lamps, low-voltage halogen lamps with conventional or electronic transformers and dimmable energy-saving halogen lamps. Mix operaton of LEDi with conventional loads possible. With manually adjustable operating mode: trailing / leading edge control. With adjustable minimum brightness. With light-level memory and minimum brightness memory. Low-noise level by MOSFET transistors. With electronic short-circuit protection. With electronic overload protection. Without control cover. For control element flex, 1gang, 64711. For control element flex, 2gang, 64721. For control element flex, 1gang, wireless, 62711-WL. For control element flex, 2gang, wireless, 62721-WL. For Busch-Watchdog 180 flex sensors, wireless, 6276x-...-WL. Rated power: 3-240 VA (LEDi) Rated voltage: 230 V~, +10 % / -10 % Rated frequency: 50 Hz Inputs: 1 Outputs: 1x dimming channel Suitable for: 230 V LEDi, typical (leading edge control) Rated power: 3 - 100 VA Suitable for: 230 V LEDi, typical (trailing edge control) Rated power: 3 - 240 W Suitable for: 230 V incandescent lamps, 230 V halogen lamps and low-voltage halogen lamps with conventional transformers or Busch Electronic Transformer. Rated power: 10 - 240 VA Temperature range (Device): -5 °C to 45 °C Dimensions: (L x W x D): 71 mm x 71 mm x 30 mm Mounting depth: 25 mm IEC 60669-2-1, British Standard EN 60669-2-1</p> 	<b>64851 U-500</b>	2CKA006500A0013	1

<sup>1)</sup> In the case of conventional transformers, take ~20% transformer loss into account.  
<sup>2)</sup> In case of electronic transformers, 5 % transformer losses.

<sup>3)</sup> Only in conjunction with standard flush-mounting boxes according to DIN 49073, erect or Busch-Jaeger No. 3040 wallbox stonework, 3050 wallbox cavity wall or 3060 wallbox concrete)

<sup>4)</sup> Recommendation: Please use loads and types of one producer.

<sup>5)</sup> The dimmer interface is not standardised, it is the responsibility of the lamp manufacturers to list compatible products in their manufacturing information. Different installation situations can lead to different results. To clear up the problem, for example, it is recommended to carry out a local test of the selected lamps and dimmers. Please consult the lamp manufacturer for the LED dimmer recommended.

<sup>6)</sup> A liability on the part of Busch-Jaeger for the compatibility of the allocated lamps and dimmers is therefore excluded.

Product	Article-No.	Order-No.	Pack/Qty
 <p><b>Extension insert flex <sup>1)</sup></b> 3 wire connection (neutral conductor required). For the extension of the Busch-Comfort switch or presence detector installations. For group control of flex inserts via extension unit communication. Operation in 1gang 2way installations via push switch- unit for combination with flush-mounted units. Without control cover. For control element flex, 1gang, wireless, 62711-WL. For control element flex, 2gang, wireless, 62721-WL. For Busch-Watchdog 180 flex sensors 6476x-... . For Busch-Watchdog 180 flex sensors, wireless, 6276x-...-WL. Combinable with all flex inserts. Rated voltage: 230 V~, +10 % / -10 % Rated frequency: 50 Hz Control/Signal outputs: 1, electronic output, potential- bound Temperature range (Device): -5 °C to 45 °C Dimensions: (L x W x D): 71 mm x 71 mm x 30 mm Mounting depth: 25 mm</p>	<b>64891 U-500</b>	2CKA006800A3051	1

<sup>1)</sup> Only in conjunction with standard flush-mounting boxes according to DIN 49073, erect or Busch-Jaeger No. 3040 wallbox stonework, 3050 wallbox cavity wall or 3060 wallbox concrete)

 <p><b>Busch-Watchdog 180 flex, basic sensor <sup>1)</sup> <sup>2)</sup> with select-lens</b> Movement detector sensor with with measurement of ambient light. For automatic switching of devices dependent on motion and brightness. Compatible with all free@home flex inserts. Adjusting elements on rear side. Extension of the detection range by means of master/ slave combination. Additional activation/deactivation option via push- button input on the flush-mounted insert. With detection display in test mode. Surveillance density: 14 sectors with 56 switching segments. Switch-off delay: approx. 10 sec - 30 min or short-time pulse 1 sec adjustable. For relay insert flex, 1gang, 64811 U. For e-contact insert flex, 1gang, 64814 U. For series relay insert flex, 2gang, 64821 U. For LED touch dimmer insert flex, 1gang, 64851 U. For extension insert flex, 64891 U. Mounting height: 22 mm. Control element: 2 controllers for setting the brightness switching threshold and switch-off delay. Detection range: frontal: 12 m, lateral: 12 m, Mounting height: 1.1 m Detection angle: 180 ° Brightness limit value: 5 Lux - 500 Lux Up to daytime operation Mounting height: 0.8 m - 1.2 m Temperature range (Device): -5 °C to 45 °C Dimensions: (L x W x D): 63 mm x 63 mm x 35 mm</p>	<b>64761-81-500</b>	2CKA006800A2921	1
anthracite	<b>64761-81-500</b>	2CKA006800A2921	1
ivory white	<b>64761-82-500</b>	2CKA006800A2923	1
studio white	<b>64761-84-500</b>	2CKA006800A2927	1
studio white, matt <sup>3)</sup>	<b>64761-884-500</b>	2CKA006800A2931	1
black matt <sup>3)</sup>	<b>64761-885-500</b>	2CKA006800A2933	1

<sup>1)</sup> Please order the respective flush-mounted insert separately.

<sup>2)</sup> The range specifications refer only to an ambient temperature of 21°C.

<sup>3)</sup> Surface painted.

## Busch-axcent®

### Movement detectors

Product	Article-No.	Order-No.	Pack/Qty
	<b>Busch-Watchdog 180 flex, comfort sensor <sup>1) 2)</sup> with select-lens</b> Movement detector sensor with with measurement of ambient light. For automatic switching of devices dependent on motion and brightness. Push switch function possible at all times. In combination with dimmer insert flex: dimming function of lighting and selectable light value storage. With enabling of pre-warning of switch-off for stairwell operation. Compatible with all free@home flex inserts. Adjusting elements on rear side. Extension of the detection range by means of master/slave combination. Additional activation/deactivation option via push-button input on the flush-mounted insert. With continuous light/continuous Off function. With detection display in test mode. Surveillance density: 14 sectors with 56 switching segments. Switch-off delay: approx. 10 sec - 30 min or short-time pulse 1 sec adjustable. For relay insert flex, 1gang, 64811 U. For e-contact insert flex, 1gang, 64814 U. For series relay insert flex, 2gang, 64821 U. For LED touch dimmer insert flex, 1gang, 64851 U. For extension insert flex, 64891 U. Mounting height: 22 mm. Control element: 2 controllers for setting the brightness switching threshold and switch-off delay. Detection range: frontal: 12 m, lateral: 12 m, Mounting height: 1.1 m Detection angle: 180 ° Brightness limit value: 5 Lux - 500 Lux Up to daytime operation Mounting height: 0.8 m - 1.2 m Temperature range (Device): -5 °C to 45 °C Dimensions: (L x W x D): 63 mm x 63 mm x 35 mm		
anthracite	<b>64762-81-500</b>	2CKA006800A2958	1
ivory white	<b>64762-82-500</b>	2CKA006800A2960	1
studio white	<b>64762-84-500</b>	2CKA006800A2964	1
studio white matt <sup>3)</sup>	<b>64762-884-500</b>	2CKA006800A2968	1
black matt <sup>3)</sup>	<b>64762-885-500</b>	2CKA006800A2970	1

<sup>1)</sup> Please order the respective flush-mounted insert separately.

<sup>2)</sup> The range specifications refer only to an ambient temperature of 21°C.

<sup>3)</sup> Surface painted.

Product	Article-No.	Order-No.	Pack/Qty
	<b>Busch-Watchdog 180 flex, comfort sensor <sup>1) 2)</sup> with multi-lens</b> Movement detector sensor with with measurement of ambient light. For automatic switching of devices dependent on motion and brightness. Push switch function possible at all times. For detection down to the floor. For detection in stairwells. With 4 detection levels. In combination with dimmer insert flex: dimming function of lighting and selectable light value storage. With enabling of pre-warning of switch-off for stairwell operation. Compatible with all free@home flex inserts. Adjusting elements on rear side. Multi-lens: suitable also for mounting heights of 2.20 m. Extension of the detection range by means of master/slave combination. Additional activation/deactivation option via push-button input on the flush-mounted insert. With continuous light/continuous Off function. With detection display in test mode. Surveillance density: 54 sectors with 224 switching segments. Switch-off delay: approx. 10 sec - 30 min or short-time pulse 1 sec adjustable. For relay insert flex, 1gang, 64811 U. For e-contact insert flex, 1gang, 64814 U. For series relay insert flex, 2gang, 64821 U. For LED touch dimmer insert flex, 1gang, 64851 U. For extension insert flex, 64891 U. Mounting height: 31 mm. Control element: 2 controllers for setting the brightness switching threshold and switch-off delay. Detection range: frontal: 8 m, lateral: 7 m, Mounting height: 1.1 m Detection range 2: frontal: 8 m, lateral: 8 m, Mounting height: 2.2 m Detection angle: 180 ° Brightness limit value: 5 Lux - 500 Lux Up to daytime operation Mounting height: 0.8 m - 1.2 m alternative: 2.2 m Temperature range (Device): -5 °C to 45 °C Dimensions: (L x W x D): 63 mm x 63 mm x 45 mm		
anthracite	<b>64764-81-500</b>	2CKA006800A2995	1
ivory white	<b>64764-82-500</b>	2CKA006800A2997	1
studio white	<b>64764-84-500</b>	2CKA006800A3001	1
studio white matt <sup>3)</sup>	<b>64764-884-500</b>	2CKA006800A3005	1
black matt <sup>3)</sup>	<b>64764-885-500</b>	2CKA006800A3007	1

<sup>1)</sup> Please order the respective flush-mounted insert separately.

<sup>2)</sup> The range specifications refer only to an ambient temperature of 21°C.

<sup>3)</sup> Surface painted.

## Busch-axcent®

### Blind control / timers

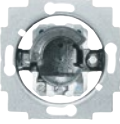
Product	Article-No.	Order-No.	Pack/Qty
	<b>Key Switch Insert <sup>1)</sup> <sup>2)</sup> <sup>3)</sup> breaking circuit, 1-pole</b> For profile semi-cylindrical lock. In switched-on and switched-off status the key can be pulled out in the central position, respectively. Delivered without cylindrical lock. Rated voltage: 250 V~ Rated current: 10 AX Suitable for: LEDi / CFLi Rated power: 100 W Protection class (Device): IP 20 IEC60669-1, British Standard EN 60669-1		
	<b>2733 USL-101</b>	2CKA001101A0914	10
<b>Mounting boxes:</b>	35 mm deep flush 1gang or Dual Box 3070-2/35 BSDB.		
<b>2gang product combinations:</b>	2gang combination with adapter plate APBS in Dual Box only.		
<b>neon indicator:</b>	not applicable		
<b>delivery form:</b>	Adapter plate APBS to be ordered separate.		

<sup>1)</sup> For installation on British Standard wallboxes please use adapter plate APBS (6599-0-2813). (Depth of box 60 mm.)

<sup>2)</sup> Use the cylindrical lock according to the enclosed drawing.

<sup>3)</sup> See profile semi-cylindrical lock.

	<b>Blind switch insert <sup>1)</sup> <sup>2)</sup> SP, switch</b> With interlock. Rated voltage: 250 V~ Rated current: 10 AX Protection class (Device): IP 20 IEC60669-1, British Standard EN 60669-1		
	<b>2000/4 US-500</b>	2CKA001012A2197	10/100
	<b>2020/4 US-500</b>	2CKA001413A1103	10/100

<sup>1)</sup> Only in conjunction with standard flush-mounting boxes according to DIN 49073, erect or Busch-Jaeger No. 3040 wallbox stonework, 3050 wallbox cavity wall or 3060 wallbox concrete)

<sup>2)</sup> These blind switches/push buttons safely prevent a switch-over of the running direction being carried out too quickly.

	<b>Blind switch insert <sup>1)</sup> <sup>2)</sup></b> With rotary knob/switch and push switch. Rated voltage: 250 V~ Rated current: 10 AX Suitable for: LEDi / CFLi Rated power: 100 W Protection class (Device): IP 20 IEC 60669-1, British Standard EN 60669-1		
	<b>DP <sup>3)</sup></b>		
	<b>2712 U</b>	2CKA001101A0534	10
	<b>SP, N, E</b>		
	<b>2713 U</b>	2CKA001101A0542	10
<b>Mounting boxes:</b>	35 mm deep flush 1gang or Dual Box 3070-2/35 BSDB.		
<b>2gang product combinations:</b>	2gang combination with adapter plate APBS in Dual Box only.		
<b>neon indicator:</b>	not applicable		
<b>delivery form:</b>	Adapter plate APBS to be ordered separate.		

<sup>1)</sup> Only in conjunction with standard flush-mounting boxes according to DIN 49073, erect or Busch-Jaeger No. 3040 wallbox stonework, 3050 wallbox cavity wall or 3060 wallbox concrete)

<sup>2)</sup> Blind switches/push switches prevents fast change over between operating directions.

<sup>3)</sup> Also suitable for controlling direct voltage drives.

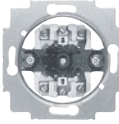
Product	Article-No.	Order-No.	Pack/Qty
	<b>Blind switch insert <sup>1)</sup> <sup>2)</sup></b> With rotary knob/push button. Rated voltage: 250 V~ Rated current: 10 A Protection class (Device): IP 20 IEC60669-1, British Standard EN 60669-1		
	<b>DP <sup>3)</sup></b>		
	<b>2722 U</b>	2CKA001101A0559	10
	<b>SP, N, E</b>		
	<b>2723 U</b>	2CKA001101A0567	10

<sup>1)</sup> Only in conjunction with standard flush-mounting boxes according to DIN 49073, erect or Busch-Jaeger No. 3040 wallbox stonework, 3050 wallbox cavity wall or 3060 wallbox concrete)

<sup>2)</sup> Blind switches/push switches prevents fast change over between operating directions.

<sup>3)</sup> Also suitable for controlling direct voltage drives.

	<b>Blind switch/push-switch <sup>1)</sup> <sup>2)</sup> <sup>3)</sup> <sup>4)</sup></b> For profile semi-cylindrical lock/switch and push-switch. Delivered without cylindrical lock. Rated voltage: 250 V~ Rated current: 10 AX Suitable for: LEDi / CFLi Rated power: 100 W Protection class (Device): IP 20 IEC60669-1, British Standard EN 60669-1		
	<b>DP <sup>3)</sup></b>		
	<b>2712 USL-101</b>	2CKA001101A0872	10
	<b>SP, N, E</b>		
	<b>2713 USL-101</b>	2CKA001101A0880	10

<sup>1)</sup> For installation on British Standard wallboxes please use adapter plate APBS (6599-0-2813). (Depth of box 60 mm.)

<sup>2)</sup> Blind switches/push switches prevents fast change over between operating directions.

<sup>3)</sup> Use the cylindrical lock according to the enclosed drawing.

<sup>4)</sup> See semi-cylindrical lock.

<sup>5)</sup> Also suitable for controlling direct voltage drives.

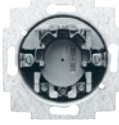
	<b>Blind switch insert <sup>1)</sup> <sup>2)</sup> <sup>3)</sup> <sup>4)</sup></b> For profile semi-cylindrical lock/push-button. Delivered without cylindrical lock. Rated voltage: 250 V~ Rated current: 10 A Protection class (Device): IP 20 British Standard EN 60669-1, IEC60669-1		
	<b>DP <sup>3)</sup></b>		
	<b>2722 USL-101</b>	2CKA001101A0898	10
	<b>SP, N, E</b>		
	<b>2723 USL-101</b>	2CKA001101A0906	10

<sup>1)</sup> For installation on British Standard wallboxes please use adapter plate APBS (6599-0-2813). (Depth of box 60 mm.)

<sup>2)</sup> Blind switches/push switches prevents fast change over between operating directions.



<sup>3)</sup> Use the cylindrical lock according to the enclosed drawing.



<sup>4)</sup> See semi-cylindrical lock.



<sup>5)</sup> Also suitable for controlling direct voltage drives.

## Busch-axcent®

### Blind control / timers

Product	Article-No.	Order-No.	Pack/Qty
 <p><b>DIN profile-semi cylindrical lock</b> Acc. to German Standard DIN 18252. Total length 40 mm for blind switches and push switches For inserts 2712/2713/2722/2723/2733 USL-101 and 2712/2733 SLW-5x. Protection class (Device): IP 20</p>	<b>different lock mechanism, with 3 keys</b>		
	<b>0520 PZ-VS</b>	2CKA000470A0013	1/100
	<b>lock mechanism, with 3 keys</b>		
	<b>0521 PZ-GS</b>	2CKA000470A0021	1/100
 <p><b>Blind compact timer</b> Suitable for blind and roller blind drives with mechanical or electronic limit switch shut-off. Without extension unit input. Running time: 3 min N-busbar connection is required. For manual and time-controlled switching of blinds and roller blinds. Memory function for the simple storage of switching times. The controlled devices can be manually operated at any time. Simple setting via display with with segment display and background illumination. Factory pre-set switching times, individual adaptations are possible. 2 switching times per day can be freely adjusted for each day of the week. Automatic switchover from summer time to winter time (switch-off function). Switching times and programs are safely stored in the event of a mains power failure. Power reserve for time and date &gt; 10 years. Simple toggling between manual/automatic/vacation modes. See the associated cover plates 6435-xx. Programming possible only with control element attached and energized. Rated voltage: 230 V~, +10 % / -10 % Rated frequency: 50 Hz Outputs: 2x Normally open contact Rated current: 3 A, cos φ 0.5 Rated power: 690 VA Temperature range (Device): 0 °C to 45 °C</p>	<b>6422 U-500</b>	2CKA006410A0410	1/10

Product	Article-No.	Order-No.	Pack/Qty
 <p><b>Basic blind insert <sup>1)</sup> <sup>2)</sup></b> <b>2-wire blind insert</b> Suitable for blind and roller blind drives with mechanical or electronic limit switch shut-off. Suitable for operation without neutral conductor. Without an extension input. For control cover 6430-xx-xxx. For standard timer control element 6456-101. Running time: 3 min. Rated voltage: 230 V~, +10 % / -10 % Rated frequency: 50 Hz Outputs: 2x Normally open contact Rated current: 3 A, cos φ 0.5 Rated power: 690 VA Temperature range (Device): 0 °C to 35 °C</p>	<b>6418 U-500</b>		
	2CKA006410A0376	1/10	
<b>Mounting boxes:</b>	35 mm deep flush 1gang or Dual Box 3070-2/35 BSDB.		
<b>2gang product combinations:</b>	2gang combination with adapter plate APBS in Dual Box only.		
<sup>1)</sup> N-conductor connection required for operation with control cover 6430-7x, illuminated.			
<sup>2)</sup> N-conductor connection may be required for operation with blind and roller blind drives with electronic limit switch shut-off. If no N-conductor is available, capacitor set 6498 can be used.			
 <p><b>Busch-Blind control II switch insert <sup>1)</sup></b> Suitable for blind, roller blind and awning drives with mechanical or electronic limit switch shut-off. With two 230 V multi-way input terminals (Up/Down) for group control. With operating mode switch for the following modes: normal, louvre, base station, position. With party function (disables the local control unit) in combination with Busch-Blind control II control cover 6430-xx-xxx, 6066-xx-xxx. Wind alarm, cleaning functions can be accommodated via extension input. For control cover 6430-xx-xxx. For IR control element 6066-xx-xxx. For comfort timer control element 6455-101-500. Running time: 3 min Rated voltage: 230 V~, +10 % / -10 % Rated frequency: 50 Hz Outputs: 2x Normally open contact Rated current: 3 A, cos φ 0.5 Rated power: 690 VA Control/Signal outputs: 2 Temperature range (Device): 0 °C to 35 °C</p>	<b>6411 U-500-101</b>		
	2CKA006410A0378	1/10	
<sup>1)</sup> Compatible with types 6411 U/x.			

 <p><b>Brightness sensor</b> For insert 6411U/S-101. With 2 m connecting cable. Measuring range: 15-50,000 lux.</p>	<b>6414-101</b>		
	2CKA006410A0389	1/10	
 <p><b>Sun sensor</b> For insert 6411U/S-101. Measuring range: 5-50,000 lux.</p>	<b>6482</b>		
	2CKA006410A0203	1	

## Busch-axcent®

### Blind control / timers

Product	Article-No.	Order-No.	Pack/Qty
	<b>Busch-Short-time timer insert 1) countdown timer</b> For time-programmed switching of electrical consumers. With control cover, without cover plate. Minimum timer time: 1 second. Maximum timer time: 9:59:59 hours. Rated voltage: 230 V~, +10 % / -10 % Rated frequency: 50 Hz Outputs: 1x Normally open contact Rated current: 10 A, cos φ 1 Rated power: 2300 VA Temperature range (Device): 0 °C to 35 °C IEC 60669-2-1, British Standard EN 60669-2-1		
	<b>6465 U-101-500</b>	2CKA006410A0393	1/10
<b>Mounting boxes:</b>	35 mm deep flush 1gang or Dual Box 3070-2/35 BSDB.		
<b>Cover frames:</b>	1gang frame 1721 BS-2xG or Dual Box frame 1722 BSDB-2xG.		
<b>2gang product combinations:</b>	2gang combination with adapter plate APBS in Dual Box only.		
<b>neon indicator:</b>	not applicable		

<sup>1)</sup> Only in conjunction with standard flush-mounting boxes according to DIN 49073, erect or Busch-Jaeger No. 3040 wallbox stonework, 3050 wallbox cavity wall or 3060 wallbox concrete)

Product	Article-No.	Order-No.	Pack/Qty
	<b>Rocker with marking</b> As cover for flush-mounted blind control switch/push switch. For inserts 2000/4 and 2020/4 US. Protection class (Device): IP 20		
anthracite	<b>1785 JA-81</b>	2CKA001751A2934	10
aluminium silver <sup>1)</sup>	<b>1785 JA-83</b>	2CKA001751A2944	10/100
studio white	<b>1785 JA-84-500</b>	2CKA001751A3088	10/100
grey metallic <sup>1)</sup>	<b>1785 JA-803</b>	2CKA001751A3020	10
studio white, matt <sup>1)</sup>	<b>1785 JA-884</b>	2CKA001751A3022	10
black matt <sup>1)</sup>	<b>1785 JA-885</b>	2CKA001751A3036	10

<sup>1)</sup> Surface painted.

Product	Article-No.	Order-No.	Pack/Qty
	<b>Cover plate with rotary control, with marking</b> As cover for flush-mounted blind control switch/push switch. For inserts 2712 U, 2713 U and 2722 U, 2723 U. Protection class (Device): IP 20		
anthracite	<b>1740-81</b>	2CKA001710A3623	10
aluminium silver <sup>1)</sup>	<b>1740-83</b>	2CKA001710A3661	10
studio white	<b>1740-84</b>	2CKA001710A3172	10/100
grey metallic <sup>1)</sup>	<b>1740-803</b>	2CKA001710A3840	10
studio white, matt <sup>1)</sup>	<b>1740-884</b>	2CKA001710A3872	10
black matt <sup>1)</sup>	<b>1740-885</b>	2CKA001710A3894	10

<sup>1)</sup> Surface painted.

Product	Article-No.	Order-No.	Pack/Qty
	<b>Cover plate 1) with labelling field</b> With marking. For half-cylindrical type switches and blind control switch/push-switch. For inserts 2733 USL-101 and 2712 USL-101, 2713 USL-101, 2722 USL-101, 2723 USL-101. Protection class (Device): IP 20		
anthracite	<b>1755 SL/PZ-81-101</b>	2CKA001710A3626	10
aluminium silver <sup>2)</sup>	<b>1755 SL/PZ-83-101</b>	2CKA001710A3662	10
studio white	<b>1755 SL/PZ-84-101</b>	2CKA001710A3175	10
grey metallic <sup>2)</sup>	<b>1755 SL/PZ-803-101</b>	2CKA001710A3841	10
studio white, matt <sup>2)</sup>	<b>1755 SL/PZ-884-101</b>	2CKA001710A3925	10
black matt <sup>2)</sup>	<b>1755 SL/PZ-885-101</b>	2CKA001710A3902	10

<sup>1)</sup> For compatible lettering software, visit [www.BUSCH-JAEGER-labelingtool.com](http://www.BUSCH-JAEGER-labelingtool.com).

<sup>2)</sup> Surface painted.

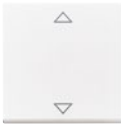
Product	Article-No.	Order-No.	Pack/Qty
	<b>Control element</b> For Busch-Blind control II insert 6411 U-101, 6411 U/S-101. For basic blind insert 6418 U. For Busch-Universal 2gang 1way insert 6402 U.		
anthracite	<b>6430-81-102</b>	2CKA006430A0326	1/10
aluminium silver <sup>1)</sup>	<b>6430-83-102</b>	2CKA006430A0328	1/10
studio white	<b>6430-84-102-500</b>	2CKA006430A0400	1/10
grey metallic <sup>1)</sup>	<b>6430-803-102</b>	2CKA006430A0350	1/10
studio white, matt <sup>1)</sup>	<b>6430-884-102</b>	2CKA006430A0385	1/10
black matt <sup>1)</sup>	<b>6430-885-102</b>	2CKA006430A0386	1/10

<sup>1)</sup> Surface painted.

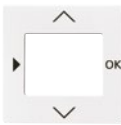
Product	Article-No.	Order-No.	Pack/Qty
	<b>Cover plate</b> For comfort timer control element 6455-101-500. For standard timer control element 6456-101. For room thermostats 1098 U-101 and 1098 UF-101. For short-time timer 6465 U-101. For Busch-CO2 sensor 1091 U-500. For blind compact timer 6422 U.		
anthracite <sup>1)</sup>	<b>6436-81</b>	2CKA006430A0387	10
aluminium silver <sup>1)</sup>	<b>6436-83</b>	2CKA006430A0357	10
studio white	<b>6435-84</b>	2CKA006430A0306	10
grey metallic <sup>1)</sup>	<b>6436-803</b>	2CKA006430A0360	10
studio white, matt <sup>1)</sup>	<b>6436-884</b>	2CKA006430A0363	10
black matt <sup>1)</sup>	<b>6435-885</b>	2CKA006430A0389	10

<sup>1)</sup> Surface painted.

<sup>2)</sup> Phase-out type

## Busch-axcent®

### Blind control / timers

Product	Article-No.	Order-No.	Pack/Qty
 <p><b>Time switch mechanism 16 A <sup>1)</sup> <sup>2)</sup></b>  <b>DP, break contact for staircases, exterior lighting, fans, etc.</b>            Running time: 15 min            For time-programmed switching of electrical consumers.            Schaltkontakte (2-polig) schließen, wenn die Laufzeit eingestellt und gestartet wird.            Schaltkontakte (2-polig) öffnen, wenn die eingestellte Zeit abgelaufen ist.            Rated voltage: 230 V~, +10 % / -10 %            Rated current: 16 A, cos φ 0.25            Protection class (Device): IP 20</p>	<b>1070 U</b>	2CKA001043A0025	1/10

<sup>1)</sup> For screw-fixing only

<sup>2)</sup> Only in conjunction with standard flush-mounting boxes according to DIN 49073, erect or Busch-Jaeger No. 3040 wallbox stonework, 3050 wallbox cavity wall or 3060 wallbox concrete)

 <p><b>Time switch mechanism 16 A <sup>1)</sup> <sup>2)</sup></b>  <b>DP, break contact for staircases, exterior lighting, fans, etc.</b>            Running time: 120 min            For time-programmed switching of electrical consumers.            Schaltkontakte (2-polig) schließen, wenn die Laufzeit eingestellt und gestartet wird.            Schaltkontakte (2-polig) öffnen, wenn die eingestellte Zeit abgelaufen ist.            Rated voltage: 230 V~, +10 % / -10 %            Rated current: 16 A, cos φ 0.25            Protection class (Device): IP 20</p>	<b>1071 U</b>	2CKA001043A0124	1
---	---------------	-----------------	---

<sup>1)</sup> For screw-fixing only

<sup>2)</sup> Only in conjunction with standard flush-mounting boxes according to DIN 49073, erect or Busch-Jaeger No. 3040 wallbox stonework, 3050 wallbox cavity wall or 3060 wallbox concrete)

Product	Article-No.	Order-No.	Pack/Qty
 <p><b>Cover plate with rotary knob, with marking</b>            For Busch-Timer insert 1070 U.            Running time: 15 min            Protection class (Device): IP 20</p>	<b>1770-81-103</b>	2CKA001753A0255	10
	<b>1770-83-103</b>	2CKA001753A0257	10
<b>1770-84-103</b>	2CKA001753A0258	10	
<b>1770-803-103</b>	2CKA001753A0254	10	
<b>1770-884-103</b>	2CKA001753A0260	10	
<b>1770-885-103</b>	2CKA001753A0261	10	

<sup>1)</sup> Surface painted.

<sup>2)</sup> Surface lacquered in aluminium.

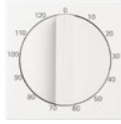
Product	Article-No.	Order-No.	Pack/Qty
 <p><b>Cover plate with rotary knob, with marking</b>            For Busch-Timer insert 1071 U.            Running time: 120 min            Protection class (Device): IP 20</p>	<b>1771-81-103</b>	2CKA001753A0265	10
	<b>1771-83-103</b>	2CKA001753A0267	10
<b>1771-84-103</b>	2CKA001753A0301	10	
<b>1771-803-103</b>	2CKA001753A0264	10	
<b>1771-884-103</b>	2CKA001753A0303	10	
<b>1771-885-103</b>	2CKA001753A0304	10	

<sup>1)</sup> Surface painted.



## Busch-axcent®

### Socket outlets

Product	Article-No.	Order-No.	Pack/Qty
	<b>SCHUKO® socket outlet</b> With screwless terminals. DP (2 P + E) Rated voltage: 250 V~ Rated current: 16 A Protection class (Device): IP 20		
anthracite	<b>20 EUC-81-500</b>	2CKA002011A6215	10/100
aluminium silver <sup>1)</sup>	<b>20 EUC-83-500</b>	2CKA002011A6213	10/100
studio white	<b>20 EUC-84-500</b>	2CKA002011A6207	10/100
grey metallic <sup>1)</sup>	<b>20 EUC-803-500</b>	2CKA002011A6216	10/100
studio white, matt	<b>20 EUC-884-500</b>	2CKA002011A6208	10
black matt <sup>1)</sup>	<b>20 EUC-885-500</b>	2CKA002011A6211	10/100

<sup>1)</sup> Surface painted.

	<b>SCHUKO® socket outlet without claw <sup>1)</sup> shuttered</b> Without claws. With screwless terminals. DP (2 P + E) Rated voltage: 250 V~ Rated current: 16 A Protection class (Device): IP 20		
anthracite	<b>20 EUCRB-81</b>	2CKA002013A5437	10/100
aluminium silver <sup>2)</sup>	<b>20 EUCRB-83</b>	2CKA002013A5439	10/100
studio white	<b>20 EUCRB-84-500</b>	2CKA002013A5441	10/100
grey metallic <sup>2)</sup>	<b>20 EUCRB-803</b>	2CKA002013A5436	10/100
studio white, matt <sup>2)</sup>	<b>20 EUCRB-884</b>	2CKA002013A5443	10
black matt <sup>2)</sup>	<b>20 EUCRB-885</b>	2CKA002013A5444	10/100

<sup>1)</sup> Increased shock protection .

<sup>2)</sup> Surface painted.

	<b>SCHUKO® socket outlet <sup>1)</sup> <sup>2)</sup> shuttered</b> With screw-type terminals. DP (2 P + E) Rated voltage: 250 V~ Rated current: 16 A Protection class (Device): IP 20		
anthracite	<b>2300 EUCB-81</b>	2CKA002013A5448	10
aluminium silver <sup>3)</sup>	<b>2300 EUCB-83</b>	2CKA002013A5450	10/100
studio white	<b>2300 EUCB-84</b>	2CKA002013A5451	10/100
grey metallic <sup>3)</sup>	<b>2300 EUCB-803</b>	2CKA002013A5447	10/100
studio white, matt <sup>3)</sup>	<b>2300 EUCB-884</b>	2CKA002013A5453	10/100
black matt <sup>3)</sup>	<b>2300 EUCB-885</b>	2CKA002013A5454	10/100

<sup>1)</sup> Increased shock protection .

<sup>2)</sup> With screw-type terminals

<sup>3)</sup> Surface painted.

Product	Article-No.	Order-No.	Pack/Qty
	<b>SCHUKO® socket outlet <sup>1)</sup> <sup>2)</sup> shuttered</b> With screw-type terminals. DP (2 P + E) Rated voltage: 250 V~ Rated current: 16 A Protection class (Device): IP 20		
anthracite	<b>23 EUCB-81</b>	2CKA002013A5474	10
ivory white	<b>23 EUCB-82</b>	2CKA002013A5475	10
aluminium silver <sup>3)</sup>	<b>23 EUCB-83</b>	2CKA002013A5476	10
studio white	<b>23 EUCB-84</b>	2CKA002013A5477	10/100
studio white, matt <sup>3)</sup>	<b>23 EUCB-884</b>	2CKA002013A5479	10
black matt <sup>3)</sup>	<b>23 EUCB-885</b>	2CKA002013A5480	10

<sup>1)</sup> Increased shock protection .

<sup>2)</sup> With screw-type terminal for rigid and flexible wires

<sup>3)</sup> Surface painted.

	<b>SCHUKO® socket outlet <sup>1)</sup> shuttered</b> With screwless terminals. DP (2 P + E) Rated voltage: 250 V~ Rated current: 16 A Protection class (Device): IP 20		
anthracite	<b>20 EUCKS-81</b>	2CKA002013A5265	10
aluminium silver <sup>2)</sup>	<b>20 EUCKS-83-500</b>	2CKA002013A5375	10/100
studio white	<b>20 EUCKS-84-500</b>	2CKA002013A5372	10/100
grey metallic <sup>2)</sup>	<b>20 EUCKS-803</b>	2CKA002013A5297	10/100
studio white, matt	<b>20 EUCKS-884-500</b>	2CKA002013A5373	10/100
black matt <sup>2)</sup>	<b>20 EUCKS-885</b>	2CKA002013A5333	10/100

<sup>1)</sup> Increased shock protection .

<sup>2)</sup> Surface painted.

## Busch-axcent®

### Socket outlets

Product	Article-No.	Order-No.	Pack/Qty
	<b>SCHUKO® USB socket outlet, 2gang<sup>1) 2) 3) 4)</sup> <b>shuttered</b> For connecting electric loads. DP (2 P + E) With screwless terminals. For supply and support of mobile devices via USB-cable. With two USB type A outputs. Simultaneous charging via USB connection and use of the SCHUKO® socket outlet. Support of loading protocol on the USB-A connection: Apple MFI with 2.4 A and BC 1.2 with 1.5 A. With electronic short-circuit protection. With electronic overload protection. Rated voltage: 230 V~, +10 % / -10 % Secondary: 5 V-, +5 % / -5 % Rated frequency: 50 Hz - 60 Hz Outputs: 2x USB charging interface Suitable for: SCHUKO® socket outlet Rated current: 16 A Suitable for: In case one output is used: Rated current: 2.4 A Output voltage: 5 V- Suitable for: In case two output are used: Rated current: 1.2 A Output voltage: 5 V- Rated power: 12 W Protection class (Device): IP 20, SELV Temperature range (Device): 5 °C to 35 °C Dimensions: (L x W x D): 71 mm x 71 mm x 58 mm Mounting depth: 39.5 mm</b>		
anthracite	<b>20 EUCB2USB-81-500</b>	2CKA002011A6268	1/10
aluminium silver <sup>5)</sup>	<b>20 EUCB2USB-83-500</b>	2CKA002011A6272	1/10
studio white	<b>20 EUCB2USB-84-500</b>	2CKA002011A6274	1/10
grey metallic <sup>5)</sup>	<b>20 EUCB2USB-803-500</b>	2CKA002011A6276	1/10
studio white matt <sup>5)</sup>	<b>20 EUCB2USB-884-500</b>	2CKA002011A6278	1/10
black matt <sup>5)</sup>	<b>20 EUCB2USB-885-500</b>	2CKA002011A6280	1/10

<sup>1)</sup> Increased shock protection .

<sup>2)</sup> Connecting terminals approved in accordance with VDE 0620-1 as connectors.

<sup>3)</sup> No data transfer.

<sup>4)</sup> When cleaning the device, use dust cover 2098 for the USB-A connection.

<sup>5)</sup> Surface painted.

	<b>Busch-Socket outlet<sup>1)</sup> shuttered</b> With screwless terminals. DP (2 P + E) With eject mechanism. Rated voltage: 250 V~ Rated current: 16 A Protection class (Device): IP 20		
anthracite	<b>20 EUCBDR-81</b>	2CKA002013A5415	10
studio white	<b>20 EUCBDR-84</b>	2CKA002013A5418	10
aluminium silver <sup>2)</sup>	<b>20 EUCBDR-83</b>	2CKA002013A5417	10
grey metallic <sup>2)</sup>	<b>20 EUCBDR-803</b>	2CKA002013A5414	10
studio white, matt <sup>2)</sup>	<b>20 EUCBDR-884</b>	2CKA002013A5420	10
black matt <sup>2)</sup>	<b>20 EUCBDR-885</b>	2CKA002013A5421	10

<sup>1)</sup> Increased shock protection .

<sup>2)</sup> Surface painted.

Product	Article-No.	Order-No.	Pack/Qty
	<b>SCHUKO® socket outlet steplight<sup>1)</sup> With night orientation light</b> with separate connection cables for switch contact. with LED, Shuttered. DP (2 P + E) Rated voltage: 250 V~ Rated current: 16 A Protection class (Device): IP 20		
anthracite	<b>20 EUCBLI-81</b>	2CKA002013A5459	1
aluminium silver <sup>2)</sup>	<b>20 EUCBLI-83</b>	2CKA002013A5293	1
studio white	<b>20 EUCBLI-84</b>	2CKA002013A5294	1
grey metallic <sup>2)</sup>	<b>20 EUCBLI-803</b>	2CKA002013A5458	1
studio white, matt <sup>2)</sup>	<b>20 EUCBLI-884</b>	2CKA002013A5326	1
black matt <sup>2)</sup>	<b>20 EUCBLI-885</b>	2CKA002013A5331	1

<sup>1)</sup> Connecting terminals approved in accordance with VDE 0620-1 as connectors.

<sup>2)</sup> Surface painted.

	<b>SCHUKO® socket outlet<sup>1)</sup> with labelling field</b> DP (2 P + E) Size of labelling field: 60 x 9 mm. Rated voltage: 250 V~ Rated current: 16 A Protection class (Device): IP 20		
anthracite	<b>20 EUN-81</b>	2CKA002011A3802	10
aluminium silver <sup>2)</sup>	<b>20 EUN-83</b>	2CKA002011A3810	10
studio white	<b>20 EUN-84-500</b>	2CKA002011A6209	10/100
grey metallic <sup>2)</sup>	<b>20 EUN-803</b>	2CKA002011A3876	10
studio white, matt <sup>2)</sup>	<b>20 EUN-884</b>	2CKA002011A3881	10
black matt <sup>2)</sup>	<b>20 EUN-885</b>	2CKA002011A3884	10

<sup>1)</sup> For compatible lettering software, visit [www.BUSCH-JAEGER-labelingtool.com](http://www.BUSCH-JAEGER-labelingtool.com).

<sup>2)</sup> Surface painted.

	<b>SCHUKO® socket outlet<sup>1) 2)</sup> with label field, increased shock protection</b> Size of labelling field: 60 x 9 mm. With screwless terminals. DP (2 P + E) Shuttered. Rated voltage: 250 V~ Rated current: 16 A Protection class (Device): IP 20		
anthracite	<b>20 EUCNB-81</b>	2CKA002013A5427	10
aluminium silver <sup>3)</sup>	<b>20 EUCNB-83</b>	2CKA002013A5429	10/100
studio white	<b>20 EUCNB-84-500</b>	2CKA002013A5431	10/100
grey metallic <sup>3)</sup>	<b>20 EUCNB-803</b>	2CKA002013A5426	10
studio white, matt <sup>3)</sup>	<b>20 EUCNB-884</b>	2CKA002013A5433	10/100
black matt <sup>3)</sup>	<b>20 EUCNB-885</b>	2CKA002013A5434	10/100

<sup>1)</sup> For compatible lettering software, visit [www.BUSCH-JAEGER-labelingtool.com](http://www.BUSCH-JAEGER-labelingtool.com).

<sup>2)</sup> Increased shock protection .

<sup>3)</sup> Surface painted.

## Busch-axcent®

### Socket outlets

Product	Article-No.	Order-No.	Pack/Qty
	<b>SCHUKO® socket outlet <sup>1)</sup> with marking "EDV"</b> With screwless terminals. DP (2 P + E) Shuttered. Rated voltage: 250 V~ Rated current: 16 A Protection class (Device): IP 20		
anthracite	<b>20 EUCKS/DV-81</b>	2CKA002013A5266	10
aluminium silver <sup>2)</sup>	<b>20 EUCKS/DV-83</b>	2CKA002013A5273	10/100
studio white	<b>20 EUCKS/DV-84</b>	2CKA002013A5268	10
grey metallic <sup>2)</sup>	<b>20 EUCKS/DV-803</b>	2CKA002013A5462	10/100
studio white, matt <sup>2)</sup>	<b>20 EUCKS/DV-884</b>	2CKA002013A5327	10
black matt <sup>2)</sup>	<b>20 EUCKS/DV-885</b>	2CKA002013A5332	10

<sup>1)</sup> Increased shock protection.

<sup>2)</sup> Surface painted.

	<b>Busch-Protector® SCHUKO® socket outlet <sup>1)</sup> with overvoltage protection</b> DP (2 P + E) With integrated and external signalling contact. ISN = 5 kA Device protection for technical sensitive equipment such as computer, entertainment electronics and building management systems. Effectively reduces overvoltage peaks occurring between the sub-distribution switch board and SCHUKO® socket outlet. Arrestor test class: classification Type 2 Rated voltage: 250 V~, Rated current: 16 A Protection class (Device): IP 20		
anthracite	<b>2310 EUGL/VA-81-11</b>	2CKA002011A3830	1
aluminium silver <sup>2)</sup>	<b>2310 EUGL/VA-83-11</b>	2CKA002011A3832	1
studio white	<b>2310 EUGL/VA-84-11</b>	2CKA002011A3833	1
red RAL 3020	<b>2310 EUGL/VA-12-82-101</b>	2CKA002011A6257	1/10
studio white, matt <sup>2)</sup>	<b>2310 EUGL/VA-884-112</b>	2CKA002011A3882	1
black matt <sup>2)</sup>	<b>2310 EUGL/VA-885-112</b>	2CKA002011A3885	1

<sup>1)</sup> Connecting terminals approved in accordance with VDE 0620-1 as connectors.

<sup>2)</sup> Surface painted.

	<b>SCHUKO® socket outlet with LED control light</b> Shuttered. DP (2 P + E) With transparent lens. LED colour green. Rated voltage: 250 V~ Rated current: 16 A Protection class (Device): IP 20		
anthracite	<b>20 EUCBL-81</b>	2CKA002013A5457	10
aluminium silver <sup>1)</sup>	<b>20 EUCBL-83</b>	2CKA002013A5285	10
studio white	<b>20 EUCBL-84</b>	2CKA002013A5286	10
grey metallic <sup>1)</sup>	<b>20 EUCBL-803</b>	2CKA002013A5456	10
studio white, matt <sup>1)</sup>	<b>20 EUCBL-884</b>	2CKA002013A5336	10
black matt <sup>1)</sup>	<b>20 EUCBL-885</b>	2CKA002013A5330	10

<sup>1)</sup> Surface painted.

Product	Article-No.	Order-No.	Pack/Qty
	<b>Busch-Object socket outlet <sup>1)</sup> shuttered</b> With screwless terminals. DP (2 P + E) Incl. Cover plate with extract mechanism. Rated voltage: 250 V~ Rated current: 16 A Protection class (Device): IP 20		
anthracite	<b>20 EUAB-81</b>	2CKA002013A5404	10
aluminium silver <sup>2)</sup>	<b>20 EUAB-83</b>	2CKA002013A5406	10
studio white	<b>20 EUAB-84</b>	2CKA002013A5407	10
grey metallic <sup>2)</sup>	<b>20 EUAB-803</b>	2CKA002013A5403	10
studio white, matt <sup>2)</sup>	<b>20 EUAB-884</b>	2CKA002013A5409	10
black matt <sup>2)</sup>	<b>20 EUAB-885</b>	2CKA002013A5410	10

<sup>1)</sup> Increased shock protection.

<sup>2)</sup> Surface painted.

	<b>FI-SCHUKOMAT, SCHUKO® socket outlet (RCD) <sup>1)</sup> <sup>2)</sup> <sup>3)</sup> with earth leakage circuit breaker</b> Shuttered. DP cut off (P,N) Without PE monitoring. With output terminals for connecting and protecting downstream SCHUKO® socket outlets. Rated fault current: 30 mA. With fixing claws. Rated frequency: 45-60 Hz. Rated voltage: 230 V~ Rated current: 16 A Protection class (Device): IP 20 Temperature range (Device): -25 °C to 40 °C		
anthracite	<b>3120 EUCB-81</b>	2CKA003116A0667	1/10
aluminium silver <sup>4)</sup>	<b>3120 EUCB-83</b>	2CKA003116A0668	1/10
studio white	<b>3120 EUCB-84</b>	2CKA003116A0662	1
grey metallic <sup>4)</sup>	<b>3120 EUCB-803</b>	2CKA003116A0666	1/10
studio white, matt <sup>4)</sup>	<b>3120 EUCB-884</b>	2CKA003116A0670	1/10
black matt <sup>4)</sup>	<b>3120 EUCB-885</b>	2CKA003116A0671	1/10

<sup>1)</sup> Connecting terminals approved in accordance with VDE 0620-1 as connectors.

<sup>2)</sup> Protective measure according to VDE 0100; can be proven or checked using the Profitest 0100S testing device, for example.

<sup>3)</sup> Increased shock protection.

<sup>4)</sup> Surface painted.

## Busch-axcent®

### Socket outlets

Product	Article-No.	Order-No.	Pack/Qty
	<b>Buschmat® FI - Insert <sup>1)</sup> with earth leakage breaker with connecting conductor</b> Protection of downstream consumers. Rated fault current: 30 mA. DP cut off (P,N) With fixing claws. Rated frequency: 45-60 Hz. Rated voltage: 230 V~ Rated current: 16 A Protection class (Device): IP 20 Temperature range (Device): -25 °C to 40 °C		
anthracite	<b>3151 UC-81</b>	2CKA003117A0009	1/10
aluminium silver <sup>2)</sup>	<b>3151 UC-83</b>	2CKA003117A0010	1/10
studio white	<b>3151 UC-84</b>	2CKA003117A0006	1/10
grey metallic <sup>2)</sup>	<b>3151 UC-803</b>	2CKA003117A0008	1/10
studio white, matt <sup>2)</sup>	<b>3151 UC-884</b>	2CKA003117A0012	1/10
black matt <sup>2)</sup>	<b>3151 UC-885</b>	2CKA003117A0013	1/10

<sup>1)</sup> Protective measure according to VDE 0100; can be proven or checked using the Profitest 0100S testing device, for example.

<sup>2)</sup> Surface painted.

	<b>SCHUKO® socket outlet with hinged lid</b> With screwless terminals. DP (2 P + E) Hinged lid notches when opened. Rated voltage: 250 V~ Rated current: 16 A Protection class (Device): IP 20		
anthracite	<b>20 EUK-81</b>	2CKA002018A1486	10
aluminium silver <sup>1)</sup>	<b>20 EUK-83</b>	2CKA002018A1487	10
studio white	<b>20 EUK-84-500</b>	2CKA002018A1509	10/100
grey metallic <sup>1)</sup>	<b>20 EUK-803</b>	2CKA002018A1493	10
antique brass <sup>2)</sup>	<b>20 EUK-840-500</b>	2CKA002018A1515	10
black matt <sup>1)</sup>	<b>20 EUK-885</b>	2CKA002018A1495	10

<sup>1)</sup> Surface painted.

<sup>2)</sup> Real metal surface refined by hand.

Product	Article-No.	Order-No.	Pack/Qty
	<b>SCHUKO® socket outlet <sup>1)</sup> with hinged lid and internal increased shock protection</b> Shuttered. With screwless terminals. DP (2 P + E) with hinged lid Rated voltage: 250 V~ Rated current: 16 A Protection class (Device): IP 20		
anthracite	<b>20 EUKB-81</b>	2CKA002018A1517	10/100
aluminium silver <sup>2)</sup>	<b>20 EUKB-83</b>	2CKA002018A1519	10/100
studio white	<b>20 EUKB-84</b>	2CKA002018A1520	10/100
grey metallic <sup>2)</sup>	<b>20 EUKB-803</b>	2CKA002018A1516	10/100
studio white, matt <sup>2)</sup>	<b>20 EUKB-884</b>	2CKA002018A1522	10/100
black matt <sup>2)</sup>	<b>20 EUKB-885</b>	2CKA002018A1523	10/100
anthracite <sup>3)</sup>	<b>20 EUKBR-81</b>	2CKA002018A1526	10/100
aluminium silver <sup>2)</sup> <sup>3)</sup>	<b>20 EUKBR-83</b>	2CKA002018A1528	10/100
studio white <sup>3)</sup>	<b>20 EUKBR-84</b>	2CKA002018A1529	10/100
grey metallic <sup>2)</sup> <sup>3)</sup>	<b>20 EUKBR-803</b>	2CKA002018A1525	10/100
studio white, matt <sup>2)</sup> <sup>3)</sup>	<b>20 EUKBR-884</b>	2CKA002018A1530	10/100
black matt <sup>2)</sup> <sup>3)</sup>	<b>20 EUKBR-885</b>	2CKA002018A1531	10/100

<sup>1)</sup> Increased shock protection .

<sup>2)</sup> Surface painted.

<sup>3)</sup> Without claw.

	<b>SCHUKO® socket outlet <sup>1)</sup> <sup>2)</sup> with hinged lid and labelling field</b> Shuttered. With screwless terminals. DP (2 P + E) with hinged lid Size of labelling field: 60 x 9 mm. Rated voltage: 250 V~ Rated current: 16 A Protection class (Device): IP 20		
anthracite	<b>20 EUKNB-81</b>	2CKA002018A1537	10/100
aluminium silver <sup>4)</sup>	<b>20 EUKNB-83</b>	2CKA002018A1539	10/100
studio white	<b>20 EUKNB-84</b>	2CKA002018A1540	10/100
grey metallic <sup>4)</sup>	<b>20 EUKNB-803</b>	2CKA002018A1536	10/100
studio white, matt <sup>4)</sup>	<b>20 EUKNB-884</b>	2CKA002018A1541	10/100
black matt <sup>4)</sup>	<b>20 EUKNB-885</b>	2CKA002018A1542	10/100

<sup>1)</sup> Increased shock protection .

<sup>2)</sup> The labels are clamped under the labelling field.

<sup>3)</sup> For compatible lettering software, visit [www.BUSCH-JAEGER-labelingtool.com](http://www.BUSCH-JAEGER-labelingtool.com).

<sup>4)</sup> Surface painted.

## Busch-axcent®

### Socket outlets

Product	Article-No.	Order-No.	Pack/Qty
	<b>SCHUKO® socket outlet <sup>1)</sup> with hinged lid and lock</b> Shuttered. With screwless terminals. DP (2 P + E) With different lock mechanism. Delivery includes 2 keys. Rated voltage: 250 V~ Rated current: 16 A Protection class (Device): IP 20		
anthracite	<b>20 EUKNBSL-81</b>	2CKA002018A1557	10
aluminium silver <sup>2)</sup>	<b>20 EUKNBSL-83</b>	2CKA002018A1561	10
studio white	<b>20 EUKNBSL-84</b>	2CKA002018A1563	10
grey metallic <sup>2)</sup>	<b>20 EUKNBSL-803</b>	2CKA002018A1555	10
studio white, matt <sup>2)</sup>	<b>20 EUKNBSL-884</b>	2CKA002018A1565	10
black matt <sup>2)</sup>	<b>20 EUKNBSL-885</b>	2CKA002018A1567	10

<sup>1)</sup> Increased shock protection .

<sup>2)</sup> Surface painted.

	<b>SCHUKO® socket outlet <sup>1)</sup> with hinged lid and lock</b> Shuttered. With screwless terminals. DP (2 P + E) With evenly engaging lock. Delivery includes 2 keys. Rated voltage: 250 V~ Rated current: 16 A Protection class (Device): IP 20		
anthracite	<b>20 EUKNBSL-81-101</b>	2CKA002018A1558	10
aluminium silver <sup>2)</sup>	<b>20 EUKNBSL-83-101</b>	2CKA002018A1562	10
studio white	<b>20 EUKNBSL-84-101</b>	2CKA002018A1564	10
grey metallic <sup>2)</sup>	<b>20 EUKNBSL-803-101</b>	2CKA002018A1556	10
studio white, matt <sup>2)</sup>	<b>20 EUKNBSL-884-101</b>	2CKA002018A1566	10
black matt <sup>2)</sup>	<b>20 EUKNBSL-885-101</b>	2CKA002018A1568	10

<sup>1)</sup> Increased shock protection .

<sup>2)</sup> Surface painted.

	<b>SCHUKO® socket outlet <sup>1)</sup> <sup>2)</sup> with hinged lid, labelling field and LED control light</b> Shuttered. With screwless terminals. DP (2 P + E) with hinged lid Size of labelling field: 60 x 9 mm. Rated voltage: 250 V~ Rated current: 16 A Protection class (Device): IP 20		
anthracite	<b>20 EUKNBL-81</b>	2CKA002018A1548	10/100
aluminium silver <sup>4)</sup>	<b>20 EUKNBL-83</b>	2CKA002018A1550	10/100
studio white	<b>20 EUKNBL-84</b>	2CKA002018A1551	10/100
grey metallic <sup>4)</sup>	<b>20 EUKNBL-803</b>	2CKA002018A1547	10/100
studio white, matt <sup>4)</sup>	<b>20 EUKNBL-884</b>	2CKA002018A1552	10/100
black matt <sup>4)</sup>	<b>20 EUKNBL-885</b>	2CKA002018A1553	10/100

<sup>1)</sup> Increased shock protection .

<sup>2)</sup> The labels are clamped under the labelling field.

<sup>3)</sup> For compatible lettering software, visit [www.BUSCH-JAEGER-labelingtool.com](http://www.BUSCH-JAEGER-labelingtool.com).

<sup>4)</sup> Surface painted.

Product	Article-No.	Order-No.	Pack/Qty
	<b>Double SCHUKO® socket outlets <sup>1)</sup> <sup>2)</sup> <sup>3)</sup> <sup>4)</sup> <sup>5)</sup></b> Complete cover. With screwless terminals. DP (2 P + E) Suitable for 1gang flush-mounted boxes. Without claws. Rated voltage: 250 V~ Rated current: 16 A Protection class (Device): IP 20		
studio white	<b>20-02 EUJR-84-503</b>	2CKA002014A1370	10

<sup>1)</sup> Separat installation only possible.

<sup>2)</sup> With 2 x 2 terminals per pole.

<sup>3)</sup> Increased shock protection .

<sup>4)</sup> Shutter for increased shock protection integrated at the socket.

<sup>5)</sup> Phase-out type

	<b>Socket outlet <sup>1)</sup> shuttered</b> Without claws. With screw-type terminals. DP Suitable for 1gang flush-mounted boxes. Rated voltage: 250 V~ Rated current: 16 A		
anthracite	<b>2300 UCRKS-81-503</b>	2CKA002113A5339	10
studio white	<b>2300 UCRKS-84-503</b>	2CKA002113A0511	10
grey metallic <sup>2)</sup>	<b>2300 UCRKS-803-503</b>	2CKA002113A5341	10
studio white, matt <sup>2)</sup>	<b>2300 UCRKS-884-503</b>	2CKA002113A5337	10
black matt <sup>2)</sup>	<b>2300 UCRKS-885-503</b>	2CKA002113A5340	10

<sup>1)</sup> Increased shock protection .

<sup>2)</sup> Surface painted.

	<b>13 A Switched socket outlet</b> SP switched 1gang Only for mounting in VDE flush-mounted wallboxes CFB 122 and CFBM 122. Rated voltage: 250 V~ Rated current: 13 ABS 1363: part2		
anthracite	<b>2190 EUC-81</b>	2CKA002190A0216	10/100
aluminium silver <sup>1)</sup>	<b>2190 EUC-83</b>	2CKA002190A0214	10
studio white	<b>2190 EUC-84</b>	2CKA002190A0215	10/100
grey metallic <sup>1)</sup>	<b>2190 EUC-803</b>	2CKA002190A0224	10/100
studio white, matt <sup>1)</sup>	<b>2190 EUC-884</b>	2CKA002190A0218	10
black matt <sup>1)</sup>	<b>2190 EUC-885</b>	2CKA002190A0219	10

<sup>1)</sup> Surface painted.

# Busch-axcent®

## Socket outlets

Product	Article-No.	Order-No.	Pack/Qty
	<b>USB socket outlet earthing pin, 2gang <sup>1)</sup> <sup>2)</sup> <sup>3)</sup> shuttered</b> For connecting electric loads. DP (2 P + E) With screwless terminals. For supply and support of mobile devices via USB-cable. With two USB type A outputs. Simultaneous charging via USB connection and use of the SCHUKO® socket outlet. Support of loading protocol on the USB-A connection: Apple MFI with 2.4 A and BC 1.2 with 1.5 A. With electronic short-circuit protection. With electronic overload protection. Suitable for the countries: Belgium, Poland, Czech Republic. Rated voltage: 230 V~, +10 % / -10 % Secondary: 5 V-, +5 % / -5 % Rated frequency: 50 Hz - 60 Hz Outputs: 2x USB charging interface Suitable for: Earth pin socket Rated current: 16 A Suitable for: In case one output is used: Rated current: 2.4 A Suitable for: In case two output are used: Rated current: 1.2 A Output voltage: 5 V- Rated power: 12 W Protection class (Device): IP 20, SELV Temperature range (Device): 5 °C to 35 °C Dimensions: (L x W x D): 71 mm x 71 mm x 58 mm Mounting depth: 39.5 mm		
anthracite	<b>20 MUCB2USB-81-500</b>	2CKA002011A6290	1
aluminium silver <sup>4)</sup>	<b>20 MUCB2USB-83-500</b>	2CKA002017A1890	1/10
studio white	<b>20 MUCB2USB-84-500</b>	2CKA002017A1891	1/10
grey metallic <sup>4)</sup>	<b>20 MUCB2USB-803-500</b>	2CKA002017A1892	1/10
studio white matt <sup>4)</sup>	<b>20 MUCB2USB-884-500</b>	2CKA002017A1893	1/10
black matt <sup>4)</sup>	<b>20 MUCB2USB-885-500</b>	2CKA002017A1894	1/10

<sup>1)</sup> Socket outlet with integrated child protection. Replaces the usual term "...with child protection".





<sup>2)</sup> No data transfer.

<sup>3)</sup> When cleaning the device, use dust cover 2098 for the USB-A connection.

<sup>4)</sup> Surface painted.

	<b>Shaver socket outlet</b> For installation into FM 2gang wall box 3030 and 3031. Rated voltage: 240 V, +10 % / -10 % Output voltage: 115 V, +10 % / -10 % Secondary: 240 V, +10 % / -10 % Rated frequency: 50 Hz - 60 Hz Rated power: 20 VA		
anthracite	<b>2332 UJBS-81</b>	2CKA002130A0297	1
aluminium silver <sup>1)</sup>	<b>2332 UJBS-83</b>	2CKA002130A0291	1
studio white	<b>2332 UJBS-84</b>	2CKA002130A0292	1
grey metallic <sup>1)</sup>	<b>2332 UJBS-803</b>	2CKA002130A0296	1
studio white, matt <sup>1)</sup>	<b>2332 UJBS-884</b>	2CKA002130A0294	1
black matt <sup>1)</sup>	<b>2332 UJBS-885</b>	2CKA002130A0295	1

<sup>1)</sup> Surface painted.

Product	Article-No.	Order-No.	Pack/Qty
	<b>Flush-mounting wall box, 2gang</b> For shaver socket outlet 2332 UJBS-8xx. Protection class (Device): IP 20 Dimensions: (L x W x D): 135 mm x 75 mm x 47 mm		
	<b>3030</b>	2CKA001741A0067	4
	<b>Flush-mounting cavity wall box, 2gang</b> For shaver socket outlet 2332 UJBS-8xx. Protection class (Device): IP 20 Dimensions: (L x W x D): 142 mm x 75 mm x 45 mm		
	<b>3031</b>	2CKA001741A0068	4
	<b>2gang European/American socket outlet, 10A</b> 2gang With screw-type terminals. SP switched Without claws. Rated voltage: 250 V~ Rated current: 10 A delivery on request		
anthracite	<b>2192-02 UC-81-500</b>		delivery on request
studio white	<b>2192-02 UC-84-500</b>		
	<b>Socket outlet <sup>1)</sup> with earth pin</b> With screwless terminals. Suitable for the countries: Belgium, Poland, Czech Republic. DP (2 P + E) Rated voltage: 250 V~ Rated current: 16 A		
	<b>20 M-500</b>	2CKA002017A0854	10/100

<sup>1)</sup> Insert can be used for all covers 2399 UCKS-xx.

	<b>Socket outlet cover frame shuttered</b> For socket outlet insert 20 M-500. Rated voltage: 250 V~		
anthracite	<b>2399 UCKS-81</b>	2CKA002099A0216	10
aluminium silver <sup>1)</sup>	<b>2399 UCKS-83</b>	2CKA002099A0241	10/100
studio white	<b>2399 UCKS-84</b>	2CKA002099A0214	10
grey metallic <sup>1)</sup>	<b>2399 UCKS-803</b>	2CKA002099A0253	10
studio white, matt <sup>1)</sup>	<b>2399 UCKS-884</b>	2CKA002099A0255	10
black matt <sup>1)</sup>	<b>2399 UCKS-885</b>	2CKA002099A0256	10/100

<sup>1)</sup> Surface painted.

## Busch-axcent®

### Socket outlets

Product	Article-No.	Order-No.	Pack/Qty
	<b>Socket outlet with earthing pin</b> With screwless terminals. Suitable for the countries like Poland, Czech Republic. DP (2 P + E) Rated voltage: 250 V~ Rated current: 16 A Protection class (Device): IP 20		
studio white	<b>20 MUC-84-500</b>	2CKA002017A0786	10/100
studio white, matt <sup>1)</sup>	<b>20 MUC-884-500</b>	2CKA002017A0859	10

<sup>1)</sup> Surface painted.

	<b>Socket outlet <sup>1)</sup> with earth. pin/increased shock protection</b> With screwless terminals. Shuttered. Suitable for the countries like Poland, Czech Republic. DP (2 P + E) Rated voltage: 250 V~ Rated current: 16 A Protection class (Device): IP 20		
anthracite	<b>20 MUCKS-81-500</b>	2CKA002017A0898	10
aluminium silver <sup>2)</sup>	<b>20 MUCKS-83-500</b>	2CKA002017A0899	10
studio white	<b>20 MUCKS-84-500</b>	2CKA002017A0807	10
grey metallic <sup>2)</sup>	<b>20 MUCKS-803-500</b>	2CKA002017A0852	10
studio white matt <sup>2)</sup>	<b>20 MUCKS-884-500</b>	2CKA002017A0901	10
black matt <sup>2)</sup>	<b>20 MUCKS-885-500</b>	2CKA002017A0902	10

<sup>1)</sup> Socket outlet with integrated child protection. Replaces the usual term "...with child protection".

<sup>2)</sup> Surface painted.

	<b>Chinese socket outlet, 10 A</b> 1gang With screw-type terminals. Without claws. According to Chinese standard: GB 2099.1 Rated voltage: 250 V~ Rated current: 10 A Rated current: 10 A delivery on request		
anthracite	<b>2193 EUC/10-81-500</b>		
	delivery on request		
studio white	<b>2193 EUC/10-84-500</b>		

	<b>Chinese socket outlet, 16 A</b> 1gang With screw-type terminals. Without claws. According to Chinese standard: GB 2099.1 Rated voltage: 250 V~ Rated current: 16 A delivery on request		
anthracite	<b>2193 EUC/16-81-500</b>		
	delivery on request		
studio white	<b>2193 EUC/16-84-500</b>		

Product	Article-No.	Order-No.	Pack/Qty
	<b>Chinese and Euro American socket outlet, 10 A</b> 1gang With screw-type terminals. Without claws. According to Chinese standard: GB 2099.1 Rated voltage: 250 V~ Rated current: 10 A delivery on request		
anthracite	<b>2195 EUC/10-81-500</b>		
	delivery on request		
studio white	<b>2195 EUC/10-84-500</b>		

	<b>International socket outlet 13A <sup>1)</sup></b> 1gang With screw-type terminals. Without claws. Rated voltage: 250 V~ Rated current: 13 A delivery on request		
anthracite	<b>2197 EUC-81-500</b>		
	delivery on request		
studio white	<b>2197 EUC-84-500</b>		

<sup>1)</sup> Usage may be restricted in certain countries.

	<b>Euro American socket outlet with earth, 16 A</b> 1gang With screw-type terminals. Without claws. Rated voltage: 250 V~ Rated current: 16 A delivery on request		
anthracite	<b>2196 EUC-81-500</b>		
	delivery on request		
studio white	<b>2196 EUC-84-500</b>		

# Busch-axcent®

## Data communication

Product	Article-No.	Order-No.	Pack/Qty
 <p><b>WLAN access point, flush-mounted <sup>1)</sup> <sup>2)</sup> power supply from mains power</b>            Operation as WLAN access point for the connection of WLAN terminal devices to the LAN.            Operation as WLAN repeater for extending the transmission range of a WLAN.            Operation as WLAN adapter for integrating Ethernet terminal devices into a WLAN.            Supports WLAN standards IEEE 802.11b/g/n with 2.4 GHz; integrated WLAN antenna.            Backward connection of an Ethernet cable via screw terminals (10/100 Mbit/s).            Front-side Ethernet connection via a RJ45 socket (10/100 Mbit/s).            The three connections (WLAN, Ethernet/screw terminals and Ethernet/RJ45) can be used in parallel via the integrated switch.            Power supply via 2-pole connecting terminal.            Nominal voltage: 100 - 240 V~            For mounting in commercially available deep flush-mounted and hollow-wall boxes.            Rated frequency: 50 Hz - 60 Hz            Protection class (Device): IP 20            Dimensions: (L x W x D): 80 mm</p>	<b>8186/31-101-500</b>	2CKA008100A0359	1

<sup>1)</sup> Suitable for cover plate 1803-xxx.

<sup>2)</sup> Not to be mounted in SM box 1701-xxx, 1702-xxx, 1703-xxx.

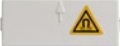
 <p><b>Reset magnet</b>            For resetting WLAN access point UP 8186/31-101 and WLAN access point PoE UP 8186/41 to the factory settings.            Protection class (Device): IP 20</p>	<b>8186/11-500</b>	2CKA008100A0361	1
--	--------------------	-----------------	---

 <p><b>Universal data connection unit, cat. 3 <sup>1)</sup> 1gang</b>            With down-leading outlet.            For 8-pole plug, RJ 11/12, RJ 45, ISDN capability, Cat. 3.            Design according to IEC 60 603-7-2:2007.            Screw contacts            With claw.            Protection class (Device): IP 20</p>	<b>0213-500</b>	2CKA000230A1549	10/100
---	-----------------	-----------------	--------

<sup>1)</sup> Suitable for cover plate 1803-xxx.

 <p><b>Universal data connection box with down-leading outlet <sup>1)</sup> 2gang internally parallel connected</b>            With down-leading outlet.            For 8-pole plug, RJ 11/12, RJ 45, ISDN capability, Cat. 3.            Design according to IEC 60 603-7-2:2007.            Screw contacts            With claw.            Protection class (Device): IP 20</p>	<b>0214</b>	2CKA000230A0235	10/100
<b>Mounting boxes:</b>	35 mm deep flush 1gang or Dual Box 3070-2/35 BSDB.		
<b>2gang product combinations:</b>	2gang combination with adapter plate APBS in Dual Box only.		
<b>neon indicator:</b>	not applicable		

<sup>1)</sup> Suitable for cover plate 1803-02-xxx.

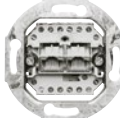
Product	Article-No.	Order-No.	Pack/Qty
 <p><b>Universal data connection box with down-leading outlet <sup>1)</sup> 2 x outlets, 8/8-pole</b>            With down-leading outlet.            For 8-pole plug, RJ 11/12, RJ 45, ISDN capability, Cat. 3.            Design according to IEC 60 603-7-2:2007.            Screw contacts            With claw.            Protection class (Device): IP 20</p>	<b>0215</b>	2CKA000230A0243	10
<b>Mounting boxes:</b>	35 mm deep flush 1gang or Dual Box 3070-2/35 BSDB.		
<b>2gang product combinations:</b>	2gang combination with adapter plate APBS in Dual Box only.		
<b>neon indicator:</b>	not applicable		

<sup>1)</sup> Suitable for cover plate 1803-02-xxx.



 <p><b>Data-connection box, RJ 45, cat. 6a iso, shielded <sup>1)</sup> 1gang</b>            With down-leading outlet and LSA self-cutting clamps.            RJ-45 terminals for networks according to Cat 6A, Class EA (10 Gbits/s / 500MHz).            Equates to cat. 6a, Class EA according to ISO/IEC 11801:2011-06.            Terminal marking A and B according to TIA/EIA-568-B.2.            Typ according to EN 60 603-7-51:2011-01.            Shielding according to DIN EN 55022, Class B.            Up to 500 MHz on all pairs of wires.            Suitable for 10-Gigabit Ethernet.            Suitable for PoE+ according to IEEE 802.3at, &gt;- 1.000 contact durability.            Flex cable entries from all sides without buckles.            Earthing of housing via 6,3 mm blade terminal at the back possible.            Re-embedded proofed.            Suitable for Mix-and-Match operation.            Suitable for RJ 11, RJ 12 und RJ 45.            For data cables with a diameter of 6 -10 mm.            For wires of AWG 24-22.            For trunk systems, flush-mounted wall boxes and underfloor systems.            Without claws.            Mounting depth: 31 mm.            Protection class (Device): IP 20</p>	<b>0218/11-101</b>	2CKA000230A0409	1/10
--	--------------------	-----------------	------



<sup>1)</sup> Suitable for cover plate 1803-xxx.



## Busch-axcent®

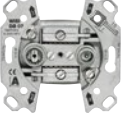

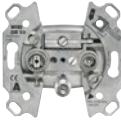

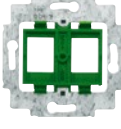
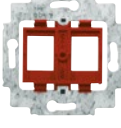
### Data communication





Product	Article-No.	Order-No.	Pack/Qty
 <p><b>Data-connection box, RJ 45, cat. 6a iso, shielded <sup>1)</sup></b>  <b>2 x outlets, 8/8-pole</b>            With down-leading outlet and LSA self-cutting clamps. RJ-45 terminals for networks according to Cat 6A, Class EA (10 Gbits/s / 500MHz). Equates to cat. 6a, Class EA according to ISO/IEC 11801:2011-06. Terminal marking A and B according to TIA/EIA-568-B.2. Typ according to EN 60 603-7-51:2011-01. Shielding according to DIN EN 55022, Class B. Up to 500 MHz on all pairs of wires. Suitable for 10-Gigabit Ethernet. Suitable for PoE+ according to IEEE 802.3at, &gt;- 1.000 contact durability. Flex cable entries from all sides without buckles. Earthing of housing via 6,3 mm blade terminal at the back possible. Re-embedded proofed. Suitable for Mix-and-Match operation. Suitable for RJ 11, RJ 12 und RJ 45. For data cables with a diameter of 6 -10 mm. For trunk systems, flush-mounted wall boxes and underfloor systems. For wires of AWG 24-22. Without claws. Mounting depth: 31 mm. Protection class (Device): IP 20</p>	<b>0218/12-101</b>	2CKA000230A0411	1/10
<sup>1)</sup> Suitable for cover plate 1803-02-xxx.			
 <p><b>Universal data connection box 8(6)/ telephone unit 6F+N - connection box <sup>1)</sup></b>  <b>2 x 6-pole</b>            with straight outlet, with screw contacts, Universal data-connection boxes: RJ 11/12, ISDN capable Cat. 3 in acc. with IEC 603-7/German Standard DIN EN 60603-7, Telecommunication outlet (telephone unit ): for 1 telephone, 1 auxiliary device or 1 data transmission unit, With claw. Protection class (Device): IP 20</p>	<b>UAE 8(6)TAE 6 F+N</b>	2CKA000230A0381	10/100
white			
<sup>1)</sup> Suitable for cover plate 2539-xxx, 1766-xxx and 1746-2xx-FN.			
 <p><b>Satellite co-axial outlets</b>  <b>2 connectors/dead-end feeder</b>            Broadband technology 5-2.400 MHz For DVB-T, satellite and broad-band cable systems. For analogue and digital transmission. With claw. Minimal installation depth, class A. Protection class (Device): IP 20</p>	<b>0230-101</b>	2CKA000230A0250	10/100
 <p><b>Antenna socket insert Radio/TV</b>  <b>2 connectors/loop through type</b>            Broadband technology 5-2.400 MHz For DVB-T, satellite and broad-band cable systems. For analogue and digital transmission. With claw. Minimal installation depth, class A. Protection class (Device): IP 20</p>	<b>0231-101</b>	2CKA000230A0268	10/100

Product	Article-No.	Order-No.	Pack/Qty
 <p><b>Satellite co-axial outlets Radio/TV/SAT</b>  <b>3gang dead-end feeder</b>            Broadband technology 47-2.150 MHz. SAT connection designed as screwable F-male plug. with remote feed via F-bush For DVB-T and broadband-cable-systems. For analogue and digital transmission. With claw. Minimal installation depth, class A. Protection class (Device): IP 20</p>	<b>0232-101-500</b>	2CKA000230A0463	10/100
 <p><b>Terminating resistor</b>  <b>75 Ohm</b>            Protection class (Device): IP 20</p>	<b>0239</b>	2CKA000230A0201	10/100
 <p><b>Mounting plate <sup>1)</sup> <sup>2)</sup></b>  <b>with green insert</b>            For 2 modular jack inserts. For systems: CommScope (AVAYA / AT&amp;T / Lucent Technologies), GigaSPEED, PowerSUM, 360 GS 10E bis MGS 600-BK, M1 BH-xx, MPS 100E-xx. With R&amp;M adapter R310694 suitable for R&amp;M connection modules R305111, R305112, R305113 and R305114. Pitch dimensions: (WxH) approx. 16.9 x 17.9 mm. Without claws. Protection class (Device): IP 20</p>	<b>1810-500</b>	2CKA001753A9974	10/100
<sup>1)</sup> Compatibility with other manufacturers not listed is to be checked in accordance with specified snap-in dimensions.			
<sup>2)</sup> For further information, please refer on the Internet.			
 <p><b>Mounting plate <sup>1)</sup> <sup>2)</sup></b>  <b>with red insert</b>            For 2 modular jack inserts. Suitable for Art. Nos. 0210, 0211 and 0219-101. For systems: AMP / tyco Electronics, BTR, EFB, Krone, Panduit, Quante, Radiall, Setec, Dr.-Ing. Sieger, Telena, Thomas &amp; Betts For Telegärtner AMJ/UMJ connection modules/ couplings. For 2 fiber optic modules of the following types: 3M-Volition, Krone, mvk. Pitch dimensions: (WxH) approx. 14.8 x 19.4 mm. Without claws. Protection class (Device): IP 20</p>	<b>1812-500</b>	2CKA001753A9972	10/100
<sup>1)</sup> Compatibility with other manufacturers not listed is to be checked in accordance with specified snap-in dimensions.			
<sup>2)</sup> For further information, please refer on the Internet.			

# Busch-axcent®

## Data communication

Product	Article-No.	Order-No.	Pack/Qty
 <p><b>Mounting plate <sup>1) 2)</sup> with black insert</b> For MTRJ or 2 modular jack inserts. For systems: Ackermann, AMP / tyco Electronics (Slim Line (SL) -SM 2gang/switches: 110Connect Jacks, Toolless Jacks / Standard 110Connect Jacks), Brand-Rex, CombiNet, EFB Electronic, Telena. For 2 fiber optic modules of the following types: AMP / tyco Electronics MTRJ. Pitch dimensions: (WxH) approx. 14.8 x 20.4 mm. Without claws. Protection class (Device): IP 20</p>	<b>1814-500</b>	2CKA001753A9973	10/100
<p><sup>1)</sup> Compatibility with other manufacturers not listed is to be checked in accordance with specified snap-in dimensions. <sup>2)</sup> For further information, please refer on the Internet.</p>			
 <p><b>Mounting plate <sup>1) 2)</sup> with blue insert</b> For 2 modular jack inserts. For system: ITT Cannon RJ45 Cat. 5 type 808 RJ45 Mark III. Pitch dimensions: (WxH) approx. 16.0 x 11.0 mm. Without claws. Protection class (Device): IP 20</p>	<b>1816</b>	2CKA001710A3100	10/100
<p><sup>1)</sup> Compatibility with other manufacturers not listed is to be checked in accordance with specified snap-in dimensions. <sup>2)</sup> For further information, please refer on the Internet.</p>			
 <p><b>Mounting plate <sup>1) 2)</sup> with orange base</b> For 2 modular jack inserts. For system: LexCom 150 and LexCom 250. Pitch dimensions: (WxH) approx. 15.4 x 15.4 mm. Without claws. Protection class (Device): IP 20</p>	<b>1819</b>	2CKA001753A8056	10/100
<p><sup>1)</sup> Compatibility with other manufacturers not listed is to be checked in accordance with specified snap-in dimensions. <sup>2)</sup> For further information, please refer on the Internet.</p>			
 <p><b>Mounting plate <sup>1) 2)</sup> with grey base</b> For 2 modular jack inserts. For system: Panduit MiniCom (Cu. z.B. TX6 10 Gig Shielded Jack modules and fiber optic modules. Pitch dimensions: (WxH) approx. 15.9 x 18.7 mm. Without claws. Protection class (Device): IP 20</p>	<b>1820</b>	2CKA001753A8057	10/100
<p><sup>1)</sup> Compatibility with other manufacturers not listed is to be checked in accordance with specified snap-in dimensions. <sup>2)</sup> For further information, please refer on the Internet.</p>			
 <p><b>Flush-mounted assembly adapter</b> For the accommodation of one or two universal modules 0219. For flush-mounted installation. Suitable for telephone connection unit cover plates 2539-21x and 1766-xxx. Protection class (Device): IP 20</p>	<b>0219/12</b>	2CKA000230A0395	1/10

Product	Article-No.	Order-No.	Pack/Qty
 <p><b>Channel assembly adapter</b> For the accommodation of one or two universal modules 0219. For channel and under-floor installation. Suitable for telephone connection unit cover plates 2539-21x and 1766-xxx. Protection class (Device): IP 20</p>	<b>0219/13</b>	2CKA000230A0396	1/10
 <p><b>Universal module, RJ 45, cat. 6a iso, shielded <sup>1)</sup> 1gang</b> For installation in installation adapter 0219/12 or 0219/13. Also suited for mounting into cover plate 2561-xxx, 2564-02-xxx and bases 1812, 1866 EB, and 1867 EB. RJ-45 terminals for networks according to Cat 6A, Class EA (10 Gbits/s / 500MHz). Equates to cat. 6a, Class EA according to ISO/IEC 11801:2011-06. Cat. 6A according to ISO/IEC 11801: 2011-06. Terminal marking A and B according to TIA/EIA-568-B.2. Typ according to EN 60 603-7-51:2011-01. Shielding according to DIN EN 55022, Class B. Suitable for PoE+ according to IEEE 802.3at, &gt;- 1.000 contact durability. Bend-radius optimised cable feed (30°). Earthing of housing via 6,3 mm blade terminal at the back possible. Re-embedded proofed. Suitable for Mix-and-Match operation. For 8-pole plug RJ 45 only. Housing made from diecast zinc. With integrated dust-protection cap (can be removed if necessary). With insulation displacement connection For data cables with a diameter of 6 -10 mm. For wires of AWG 24-22. For trunk systems, flush-mounted wall boxes and underfloor systems. Protection class (Device): IP 20</p>	<b>0219-101</b>	2CKA000230A0413	1/10
<p><sup>1)</sup> With assembly adapters appropriate for telephone unit cover plates 2539-21x and 1766-xxx.</p>			
 <p><b>Modular-Jack insert 6-pole Cat. 3 (AMP-No. 216000-2)</b> For cover plate 2561-xxx, 2561-02-xxx and insert 1812, 1866 built-in, 1867 built-in. For conductor cross-sections of 0.12 mm<sup>2</sup> (AWG 26) to 0.35 mm<sup>2</sup> (AWG 22). Protection class (Device): IP 20</p>	<b>0210</b>	2CKA000225A0078	10
 <p><b>Modular-Jack insert 8-pole Cat. 3 (AMP-No. 216005-4)</b> For cover plate 2561-xxx, 2561-02-xxx and insert 1812, 1866 built-in, 1867 built-in. For conductor cross-sections of 0.12 mm<sup>2</sup> (AWG 26) to 0.35 mm<sup>2</sup> (AWG 22). Protection class (Device): IP 20</p>	<b>0211</b>	2CKA000225A0086	10

## Busch-axcent®

### Data communication

Product	Article-No.	Order-No.	Pack/Qty
 <p><b>Built-in jack</b> For potential balancing jack cover plate and installation in cover plates. For devices of 19 mm diameter. Protection class (Device): IP 20</p>	<b>0471-0-0037</b>	2CKA000471A0037	10

 <p><b>Potential balancing plug</b> Suitable for plug 2095 UC-212 and built-in jack 0471-0-0037 acc. to German Standard DIN 42801. For potential balancing jack cover plate (connection up to 6 mm<sup>2</sup> crimped or soldered) Protection class (Device): IP 20</p>	<b>0299-0-0032</b>	2CKA000299A0032	10
---	--------------------	-----------------	----

 <p><b>Blank plate with metal mounting plate</b> Protection class (Device): IP 20</p>	anthracite	<b>1742-81</b>	2CKA001710A3612	10
	aluminium silver <sup>1)</sup>	<b>1742-83</b>	2CKA001710A3664	10
	studio white	<b>1742-84-500</b>	2CKA001710A3991	10/100
	grey metallic <sup>1)</sup>	<b>1742-803</b>	2CKA001710A3843	10
	studio white, matt <sup>1)</sup>	<b>1742-884</b>	2CKA001710A3873	10/100
	black matt <sup>1)</sup>	<b>1742-885</b>	2CKA001710A3895	10

<sup>1)</sup> Surface painted.

 <p><b>Cover plate <sup>1)</sup></b> As cover for flex outlet, for cords up to 10.3 mm diameter. With strain relief (without terminal block). Protection class (Device): IP 20</p>	anthracite	<b>1749-81</b>	2CKA001710A3614	10
	aluminium silver <sup>2)</sup>	<b>1749-83</b>	2CKA001710A3665	10
	studio white	<b>1749-84</b>	2CKA001710A3163	10/100
	grey metallic <sup>2)</sup>	<b>1749-803</b>	2CKA001710A3844	10
	studio white, matt <sup>2)</sup>	<b>1749-884</b>	2CKA001710A3878	10
	black matt <sup>2)</sup>	<b>1749-885</b>	2CKA001710A3900	10

<sup>1)</sup> Cover plate can also be used individually as cover for telephone connector boxes (VDo).

<sup>2)</sup> Surface painted.

Product	Article-No.	Order-No.	Pack/Qty	
 <p><b>Cover plate <sup>1)</sup></b> As cover for universal data connection boxes. Art.-No. 0213 (Cat 3/ISDN), 0216-101, 0218/11-101 (Cat 5e/6 data technology) and comparable types of the company Rutenbeck. For WLAN access points 8186/31 and 8186/41. Brand-Rex (WAEGV 8 EKR/EK). BTR (universal data connecting unit design and IAE design). Telegärtner (AMJ 45, UMJ 45). With down-leading outlet. With labelling field. Size of labelling field: 60 x 9 mm. Protection class (Device): IP 20</p>	anthracite	<b>1803-81</b>	2CKA001710A3616	10
	aluminium silver <sup>2)</sup>	<b>1803-83</b>	2CKA001710A3674	10
	studio white	<b>1803-84-500</b>	2CKA001710A1550	10/100
	grey metallic <sup>2)</sup>	<b>1803-803</b>	2CKA001710A3852	10
	studio white, matt <sup>2)</sup>	<b>1803-884</b>	2CKA001710A3889	10
	black matt <sup>2)</sup>	<b>1803-885</b>	2CKA001710A3912	10

<sup>1)</sup> For compatible lettering software, visit [www.BUSCH-JAEGER-labelingtool.com](http://www.BUSCH-JAEGER-labelingtool.com).

<sup>2)</sup> Surface painted.

 <p><b>Cover plate <sup>1)</sup> 2gang</b> As cover for universal data connection boxes. Art. No. 0214, 0215 (Cat 3), 0220/12-507, 0221/12-507, 0218, 0217 (Cat 5e/6 data technology) and comparable types of the company Rutenbeck. Brand-Rex (WAEGV 8/8 EKR/EK). AMP (NETCONNECT 5E). BTR (E-DAT C6, E-DAT design, Universal data connecting unit design and IAE design). cti (cti-wire 2.8 Cat.6). Telegärtner (AMJ 45, UMJ 45). With down-leading outlet. With labelling field. Size of labelling field: 60 x 9 mm. Protection class (Device): IP 20</p>	anthracite	<b>1803-02-81</b>	2CKA001710A3615	10
	aluminium silver <sup>2)</sup>	<b>1803-02-83</b>	2CKA001710A3610	10/100
	studio white	<b>1803-02-84-500</b>	2CKA001710A1551	10/100
	grey metallic <sup>2)</sup>	<b>1803-02-803</b>	2CKA001710A3853	10
	studio white, matt <sup>2)</sup>	<b>1803-02-884</b>	2CKA001710A3888	10
	black matt <sup>2)</sup>	<b>1803-02-885</b>	2CKA001710A3911	10

<sup>1)</sup> For compatible lettering software, visit [www.BUSCH-JAEGER-labelingtool.com](http://www.BUSCH-JAEGER-labelingtool.com).

<sup>2)</sup> Surface painted.

# Busch-axcent®

## Data communication

Product	Article-No.	Order-No.	Pack/Qty
	<b>Cover plate</b> For telephone connection unit. For USB, VGA, HDMI inserts and communication adapter. USB power adapter insert 6472 U. For loudspeaker connection box. Suitable for part number 0248/0x-101. For data modules. Suitable for Art. No. 0219/12 and 0219/13. For modular outlets with 90° RJ45 outlet from Telegärtner (type MJ and WE). Protection class (Device): IP 20		
anthracite	<b>1766-81</b>	2CKA001710A3613	10
aluminium silver <sup>1)</sup>	<b>1766-83</b>	2CKA001710A3659	10/100
studio white	<b>1766-84-500</b>	2CKA001710A3992	10/100
grey metallic <sup>1)</sup>	<b>1766-803</b>	2CKA001710A3854	10
studio white, matt <sup>1)</sup>	<b>1766-884</b>	2CKA001710A3926	10
black matt <sup>1)</sup>	<b>1766-885</b>	2CKA001710A3903	10

<sup>1)</sup> Surface painted.

	<b>Cover plate</b> As cover for telephone connector boxes (VDo). Can be knocked out for single or double connection. Protection class (Device): IP 20		
anthracite	<b>1745-81</b>	2CKA001710A3624	10
studio white	<b>1745-84</b>	2CKA001710A3173	10
grey metallic <sup>1)</sup>	<b>1745-803</b>	2CKA001710A3855	10
black matt <sup>1)</sup>	<b>1745-885</b>	2CKA001710A3896	10
aluminium silver <sup>1)</sup>	<b>1745-83</b>	2CKA001710A3675	10
studio white, matt <sup>1)</sup>	<b>1745-884</b>	2CKA001710A3874	10

<sup>1)</sup> Surface painted.

	<b>Cover plate <sup>1)</sup> socket outlet</b> Telephone socket (TDO)		
anthracite	<b>1762-81-506</b>	2CKA001710A4103	10/100
aluminium silver <sup>2)</sup>	<b>1762-83-506</b>	2CKA001710A4105	10/100
studio white	<b>1762-84-506</b>	2CKA001710A4106	10/100
grey metallic <sup>2)</sup>	<b>1762-803-506</b>	2CKA001710A4102	10/100
studio white matt <sup>2)</sup>	<b>1762-884-506</b>	2CKA001710A4108	10/100
black matt <sup>2)</sup>	<b>1762-885-506</b>	2CKA001710A4109	10/100

<sup>1)</sup> Suitable insert: TDO 3x 10 OUP (for 1 telephone and 2 auxiliary devices).

<sup>2)</sup> Surface painted.

Product	Article-No.	Order-No.	Pack/Qty
	<b>Cover plate <sup>1) 2)</sup> as cover for standard Radio/TV/SAT socket outlets</b> With 2 connectors Acc. to German Standard DIN 45330. Radio/TV/SAT. With M3 fixing screw. Protection class (Device): IP 20		
anthracite	<b>1743-81</b>	2CKA001724A4252	10
aluminium silver <sup>3)</sup>	<b>1743-83</b>	2CKA001724A4262	10
studio white	<b>1743-84-500</b>	2CKA001724A4332	10/100
grey metallic <sup>3)</sup>	<b>1743-803</b>	2CKA001724A4291	10
studio white, matt <sup>3)</sup>	<b>1743-884</b>	2CKA001724A4293	10/100
black matt <sup>3)</sup>	<b>1743-885</b>	2CKA001724A4298	10/100

<sup>1)</sup> Third opening can be knocked out.

<sup>2)</sup> See inserts for satellite coaxial socket outlets.

<sup>3)</sup> Surface painted.

	<b>Cover plate</b> As cover for 4gang Satellite co-axial socket outlet EVU 02 F, GEVU 15 S from Hirschmann. Protection class (Device): IP 20		
anthracite	<b>1743-04-81</b>	2CKA001724A4374	10
aluminium silver <sup>1)</sup>	<b>1743-04-83</b>	2CKA001724A4376	10
studio white	<b>1743-04-84</b>	2CKA001724A4377	10
grey metallic <sup>1)</sup>	<b>1743-04-803</b>	2CKA001724A4373	10
studio white, matt <sup>1)</sup>	<b>1743-04-884</b>	2CKA001724A4379	10
black matt <sup>1)</sup>	<b>1743-04-885</b>	2CKA001724A4380	10

<sup>1)</sup> Surface painted.

	<b>Cover plate</b> As cover for 4gang Satellite co-axial socket outlet SAT400/EAS/DC, EAS 405, 413 DAS from Ankaro. Protection class (Device): IP 20		
anthracite	<b>1743/10-04-81</b>	2CKA001724A4365	10
aluminium silver <sup>1)</sup>	<b>1743/10-04-83</b>	2CKA001724A4367	10
studio white	<b>1743/10-04-84</b>	2CKA001724A4368	10/100
grey metallic <sup>1)</sup>	<b>1743/10-04-803</b>	2CKA001724A4364	10
studio white, matt <sup>1)</sup>	<b>1743/10-04-884</b>	2CKA001724A4370	10
black matt <sup>1)</sup>	<b>1743/10-04-885</b>	2CKA001724A4371	10

<sup>1)</sup> Surface painted.

## Busch-axcent®

### Data communication

Product	Article-No.	Order-No.	Pack/Qty
	<b>Cover plate <sup>1)</sup> with labelling field</b> For modular jack with slide entrance. To fit only Art. No. 1810, 1812, 1814, 1816, 1818, 1819 and 1820. Size of labelling field: 60 x 9 mm. Protection class (Device): IP 20		
anthracite	<b>1800-81</b>	2CKA001710A3627	10
aluminium silver <sup>2)</sup>	<b>1800-83</b>	2CKA001710A3676	10
studio white	<b>1800-84-500</b>	2CKA001710A3990	10/100
grey metallic <sup>2)</sup>	<b>1800-803</b>	2CKA001710A3856	10
studio white, matt <sup>2)</sup>	<b>1800-884</b>	2CKA001710A3887	10
black matt <sup>2)</sup>	<b>1800-885</b>	2CKA001710A3910	10

<sup>1)</sup> For compatible lettering software, visit [www.BUSCH-JAEGER-labelingtool.com](http://www.BUSCH-JAEGER-labelingtool.com).

<sup>2)</sup> Surface painted.

	<b>Cover plate</b> For 1 modular jack. Suitable for Art. Nos. 0210, 0211 and 0219-101. Without claws. Protection class (Device): IP 20		
anthracite	<b>2561-81</b>	2CKA001753A0400	10
aluminium silver <sup>1)</sup>	<b>2561-83</b>	2CKA001753A0402	10
studio white	<b>2561-84</b>	2CKA001753A0403	10
grey metallic <sup>1)</sup>	<b>2561-803</b>	2CKA001753A0399	10
studio white, matt <sup>1)</sup>	<b>2561-884</b>	2CKA001753A0405	10
black matt <sup>1)</sup>	<b>2561-885</b>	2CKA001753A0406	10

<sup>1)</sup> Surface painted.

	<b>Cover plate</b> For 2 modular jack inserts. Suitable for Art. No. 0210 and 0211. Without claws. Protection class (Device): IP 20		
anthracite	<b>2561-02-81</b>	2CKA001753A0317	10
aluminium silver <sup>1)</sup>	<b>2561-02-83</b>	2CKA001753A0393	10
studio white	<b>2561-02-84</b>	2CKA001753A0394	10
grey metallic <sup>1)</sup>	<b>2561-02-803</b>	2CKA001753A0316	10
black matt <sup>1)</sup>	<b>2561-02-885</b>	2CKA001753A0397	10
studio white, matt <sup>1)</sup>	<b>2561-02-884</b>	2CKA001753A0396	10

<sup>1)</sup> Surface painted.

Product	Article-No.	Order-No.	Pack/Qty
	<b>Cover plate</b> For telecommunication inserts with cover plate 50 x 50 mm. With cover plate 50 x 50 mm, AMP, Brand-Rex, Rutenbeck, BTR, Telegärtner, etc. Protection class (Device): IP 20		
anthracite	<b>1746/10-81</b>	2CKA001710A3628	10
aluminium silver <sup>1)</sup>	<b>1746/10-83</b>	2CKA001710A3677	10
studio white	<b>1746/10-84-500</b>	2CKA001710A3993	10/100
grey metallic <sup>1)</sup>	<b>1746/10-803</b>	2CKA001710A3857	10
studio white, matt <sup>1)</sup>	<b>1746/10-884</b>	2CKA001710A3875	10
black matt <sup>1)</sup>	<b>1746/10-885</b>	2CKA001710A3897	10

<sup>1)</sup> Surface painted.

	<b>Intermediate ring Reflex SI/SI Linear</b> For fitting cover plates from the Busch-Duro 2000® SI and Reflex SI range. Protection class (Device): IP 20		
studio white	<b>1747 SI-84</b>	2CKA001710A3863	10
aluminium silver <sup>1)</sup>	<b>1747 SI-83</b>	2CKA001710A4091	10

<sup>1)</sup> Surface painted.

	<b>Intermediate ring Busch-balance® SI</b> For attaching cover plates from the Busch-balance® SI range. Delivery without cover plate. Protection class (Device): IP 20		
anthracite	<b>1747 BSI-81</b>	2CKA001710A4093	10
aluminium silver <sup>1)</sup>	<b>1747 BSI-83</b>	2CKA001710A4095	10
studio white	<b>1747 BSI-84</b>	2CKA001710A4096	10/100
grey metallic <sup>1)</sup>	<b>1747 BSI-803</b>	2CKA001710A4092	10
studio white, matt <sup>1)</sup>	<b>1747 BSI-884</b>	2CKA001710A4098	10
black matt <sup>1)</sup>	<b>1747 BSI-885</b>	2CKA001710A4099	10

<sup>1)</sup> Surface painted.

	<b>Cover plate <sup>1)</sup> with hinged lid.</b> For telecommunication inserts with cover plate 50 x 50 mm. With cover plate 50 x 50 mm, AMP, Brand-Rex, Rutenbeck, BTR, Telegärtner, etc. Protection class (Device): IP 20		
anthracite	<b>1746-81</b>	2CKA001710A3618	10
aluminium silver <sup>2)</sup>	<b>1746-83</b>	2CKA001710A3678	10
studio white	<b>1746-84</b>	2CKA001710A3167	10
grey metallic <sup>2)</sup>	<b>1746-803</b>	2CKA001710A3858	10
studio white, matt <sup>2)</sup>	<b>1746-884</b>	2CKA001710A3876	10
black matt <sup>2)</sup>	<b>1746-885</b>	2CKA001710A3898	10

<sup>1)</sup> Combinable only with covers for flush-mounted inserts

<sup>2)</sup> Surface painted.

# Busch-axcent®

## Data communication

Product	Article-No.	Order-No.	Pack/Qty
	<b>Intermediate ring with hinged lid <sup>1)</sup> Busch-balance® SI</b> For attaching cover plates from the Busch-balance® SI range. Delivery without cover plate. With sealing ring. With hinged lid. Protection class (Device): IP 44 Dimensions: (L x W x D): 63 mm x 63 mm x 20 mm		
anthracite	<b>2518-WD-81</b>	2CKA001719A0217	10
aluminium silver <sup>2)</sup>	<b>2518-WD-83</b>	2CKA001719A0219	10
studio white	<b>2518-WD-84</b>	2CKA001719A0220	10
grey metallic <sup>2)</sup>	<b>2518-WD-803</b>	2CKA001719A0216	10
studio white, matt <sup>2)</sup>	<b>2518-WD-884</b>	2CKA001719A0222	10
black matt <sup>2)</sup>	<b>2518-WD-885</b>	2CKA001719A0223	10

<sup>1)</sup> Combinable only with covers for flush-mounted inserts

<sup>2)</sup> Surface painted.

	<b>XLR centre plate</b> As cover for Neutrik plug connectors, type D series. Without claws. Protection class (Device): IP 20		
anthracite	<b>2553-81</b>	2CKA001724A4399	10
aluminium silver <sup>1)</sup>	<b>2553-83</b>	2CKA001724A4401	10
studio white	<b>2553-84</b>	2CKA001724A4402	10
grey metallic <sup>1)</sup>	<b>2553-803</b>	2CKA001724A4398	10
studio white, matt <sup>1)</sup>	<b>2553-884</b>	2CKA001724A4404	10
black matt <sup>1)</sup>	<b>2553-885</b>	2CKA001724A4405	10

<sup>1)</sup> Surface painted.

	<b>Cover plate with metal mounting plate</b> For covering universal data communication connectors and circular connectors with screwed plug M 16x0.75 (installable in insert) in accordance with DIN 41524, 41529, 45322, 45327, 45328 and 45329. Knock-out openings 6, 8, 18 mm. Protection class (Device): IP 20		
anthracite	<b>1748-81</b>	2CKA001710A3654	10
aluminium silver <sup>1)</sup>	<b>1748-83</b>	2CKA001710A3673	10
studio white	<b>1748-84</b>	2CKA001710A3656	10
grey metallic <sup>1)</sup>	<b>1748-803</b>	2CKA001710A3851	10
studio white, matt <sup>1)</sup>	<b>1748-884</b>	2CKA001710A3877	10
black matt <sup>1)</sup>	<b>1748-885</b>	2CKA001710A3899	10

<sup>1)</sup> Surface painted.

Product	Article-No.	Order-No.	Pack/Qty
	<b>Cover plate with metal mounting plate</b> As cover for BNC and TNC sockets. Knock-out openings 6, 8, 18 mm. Protection class (Device): IP 20		
anthracite	<b>1750-81</b>	2CKA001710A3617	10
aluminium silver <sup>1)</sup>	<b>1750-83</b>	2CKA001710A3679	10
studio white	<b>1750-84</b>	2CKA001710A3166	10
grey metallic <sup>1)</sup>	<b>1750-803</b>	2CKA001710A3859	10
studio white, matt <sup>1)</sup>	<b>1750-884</b>	2CKA001710A3879	10
black matt <sup>1)</sup>	<b>1750-885</b>	2CKA001710A3901	10

<sup>1)</sup> Surface painted.

	<b>Equipotential socket outlet 2gang</b> Without claws. For connecting wires up to 1 x 6 mm <sup>2</sup> and 4 x 2.5 mm <sup>2</sup> . IEC 60601-1:2005; DIN EN 60601 (VDE 0750-1): July 2007 Connection bolts German Standard DIN 42801. Protection class (Device): IP 20		
anthracite	<b>2095 UC-81</b>	2CKA002495A0084	10
aluminium silver <sup>1)</sup>	<b>2095 UC-83</b>	2CKA002495A0089	10
studio white	<b>2095 UC-84</b>	2CKA002495A0086	10
grey metallic <sup>1)</sup>	<b>2095 UC-803</b>	2CKA002495A0097	10
studio white, matt <sup>1)</sup>	<b>2095 UC-884</b>	2CKA002495A0091	10
black matt <sup>1)</sup>	<b>2095 UC-885</b>	2CKA002495A0092	10

<sup>1)</sup> Surface painted.

	<b>Cover plate with metal mounting plate</b> With screw-type terminal. Fixed with central locknut. As cover for pilot devices with a diameter of 22.5 mm Without claws. Protection class (Device): IP 20		
anthracite	<b>2533-81</b>	2CKA001724A4254	10
aluminium silver <sup>1)</sup>	<b>2533-83</b>	2CKA001724A4261	10
studio white	<b>2533-84</b>	2CKA001724A4256	10
grey metallic <sup>1)</sup>	<b>2533-803</b>	2CKA001724A4407	10
studio white, matt <sup>1)</sup>	<b>2533-884</b>	2CKA001724A4296	10
black matt <sup>1)</sup>	<b>2533-885</b>	2CKA001724A4301	10

<sup>1)</sup> Surface painted.

## Busch-axcent®

### Data communication

Product	Article-No.	Order-No.	Pack/Qty
	<b>Cover plate <sup>1)</sup> with metal mounting plate</b> for communication devices. With labelling field 60.2 x 10.2 mm. Without claws. Protection class (Device): IP 20		
anthracite	<b>1758-81</b>	2CKA001724A4253	10
aluminium silver <sup>2)</sup>	<b>1758-83</b>	2CKA001724A4263	10
studio white	<b>1758-84</b>	2CKA001724A2761	10/100
grey metallic <sup>2)</sup>	<b>1758-803</b>	2CKA001724A4292	10
studio white, matt <sup>2)</sup>	<b>1758-884</b>	2CKA001710A3881	1
black matt <sup>2)</sup>	<b>1758-885</b>	2CKA001724A4299	10

<sup>1)</sup> For compatible lettering software, visit [www.BUSCH-JAEGER-labelingtool.com](http://www.BUSCH-JAEGER-labelingtool.com).

<sup>2)</sup> Surface painted.



### Multimedia / communication adapters

Product	Article-No.	Order-No.	Pack/Qty
	<b>Busch-Radio DAB+ <sup>1)</sup></b> DAB+ and RDS stereo radio alarm clock for flush-mounted installation. With high-resolution colour display for showing additional information. Reception frequency: 87.50 MHz - 108.00 MHz. Receive frequency (DAB+): 174 MHz - 240 MHz. With external AUX input/output, reversible. For mono/stereo operation. 8 radio stations storable. With time and date display. With individual alarm and snooze function. With automatic switch-off function (automatic sleep mode). With extension input to remote-controlled ON/OFF switches. With integrated antenna. With additional connection for external antenna. Permitted speaker impedance: 4 - 8 Ohm Can be installed as 1gang and in multiple combinations. Control element: 4-button operation via floating rocker Display elements: ICU graphic display with 280 DPI. Rated voltage: 230 V~, +10 % / -10 % Rated frequency: 50 Hz - 60 Hz Control/Signal outputs: 2, Loudspeaker output, impedance 4 Ohm Rated power: 2 W (RMS)		
		Protection class (Device): IP 20 Temperature range (Device): 5 °C to 40 °C Dimensions: (L x W x D): 71 mm x 71 mm x 47 mm Mounting depth: 32 mm	
	<b>8215 U-101-500</b>	2CKA008200A0276	1/10



<sup>1)</sup> No claw. Screw-fixing via keyholes.

## Busch-axcent®

### Multimedia / communication adapters

Product	Article-No.	Order-No.	Pack/Qty
 <p><b>Busch-Radio BTconnect DAB+ 1)</b>  <b>With Bluetooth interface for music replay.</b>            DAB+ and RDS stereo radio alarm clock for flush-mounted installation.            With high-resolution colour display for showing additional information.            With Bluetooth interface for music replay of mobile devices.            Connection of external Bluetooth loudspeakers possible.            Reception frequency: 87.50 MHz - 108.00 MHz.            Receive frequency (DAB+): 174 MHz – 240 MHz.            With external AUX input/output, reversible.            For mono/stereo operation.            8 radio stations storable.            With time and date display.            With individual alarm and snooze function.            With automatic switch-off function (automatic sleep mode).            With extension input to remote-controlled ON/OFF switches.            With integrated antenna.            With additional connection for external antenna.            Permitted speaker impedance: 4 - 8 Ohm            Can be installed as 1gang and in multiple combinations.            Bluetooth specification: 4.2.            Bluetooth profiles supported: A2DP            Number of stored Bluetooth connections: max. 8            Control element: 4-button operation via floating rocker            Display elements: ICU graphic display with 280 DPI.            Rated voltage: 230 V~, +10 % / -10 %            Rated frequency: 50 Hz - 60 Hz            Rated power: 2 W (RMS)</p> <p>Protection class (Device): IP 20            Temperature range (Device): 5 °C to 40 °C            Dimensions: (L x W x D): 71 mm x 71 mm x 47 mm            Mounting depth: 32 mm</p> 	<b>8217 U-101-500</b>	2CKA008200A0279	1/10

<sup>1)</sup> No claw. Screw-fixing via keyholes.

Product	Article-No.	Order-No.	Pack/Qty
 <p><b>Busch-Radio iNet 1) 2) 3) 4)</b>            WLAN Internet radio alarm clock for flush-mounted installation.            For the reception of national and international radio stations via Internet.            Radio station search possible via various genres.            With high resolution graphic display and background illumination.            With external AUX input.            Integrated web-server for configuration and control.            Remote operation with smartphone via browser surface.            UPnP replay function. It is controlled via smartphone.            For mono/stereo operation.            8 radio stations storable.            With time and date display.            With alarm function.            With short-time timer.            With automatic switch-off function (automatic sleep mode).            With extension input to remote-controlled ON/OFF switches.            With integrated WLAN antenna.            WLAN Standards: IEEE 802.11b / IEEE 802.11g and IEEE 802.11n (2,4 GHz).            WLAN safety: WPA / WPA2.            Permitted speaker impedance: 4 - 8 Ohm            Can be installed as 1gang and in multiple combinations.            Rated voltage: 110 - 230 V~, +10 % / -10 %            Rated frequency: 50 Hz - 60 Hz            Protection class (Device): IP 20            Temperature range (Device): 5 °C to 40 °C            Dimensions: (L x W x D): 71 mm x 71 mm x 49 mm            Mounting depth: 33 mm</p> 	<b>8216 U-500</b>	2CKA008200A0153	1/10

<sup>1)</sup> No claw. Screw-fixing via keyholes.

<sup>2)</sup> Matching loudspeaker insert 8223 U.

<sup>3)</sup> Can also be combined with built-in loudspeaker (8222 EB) and moist atmosphere loudspeaker (8224 EB).

<sup>4)</sup> To be mounted only in connection with commercially available flush-mounted installation boxes according to DIN 49073 > 40 mm depth gauge or Busch-Jaeger art. no. 3040, 3050 or 3060.

 <p><b>Busch-Radio DAB+, complete set 1)</b>            Ready-to-install DAB+ radio alarm clock for mono operation (set packaged).            With high-resolution colour display for showing additional information.            Consisting of the Busch-Radio DAB+ 8215 U-101.            Consisting of speaker insert 8223 U.            Consisting of the cover plate for Busch-Radio 8252-84-101.            Consisting of cover plate for speaker insert 8253-84.            Consisting of 2gang future® linear cover frame 1722-184K.            Rated voltage: 230 V~, +10 % / -10 %            Rated frequency: 50 Hz - 60 Hz            Protection class (Device): IP 20            Temperature range (Device): 5 °C to 40 °C            Dimensions: (L x W x D): 150 mm x 80 mm x 49 mm            Mounting depth: 32 mm</p>	<b>8220 UJ-84-101-500</b>	2CKA008200A0234	1
---	---------------------------	-----------------	---

<sup>1)</sup> No claw. Screw-fixing via keyholes.





## Busch-axcent®

### Multimedia / communication adapters

Product	Article-No.	Order-No.	Pack/Qty
 <p><b>Busch-Radio BTconnect DAB+, complete set <sup>1)</sup></b>  <b>With Bluetooth interface for music replay.</b>            Ready-to-install DAB+ radio alarm clock for mono operation (set packaged).            With high-resolution colour display for showing additional information.            With Bluetooth interface for music replay of mobile devices.            Connection of external Bluetooth loudspeakers possible.            Consisting of the Busch-Radio BTconnect DAB+ 8217 U-101.            Consisting of speaker insert 8223 U.            Consisting of the cover plate for Busch-Radio 8252-84-101.            Consisting of cover plate for speaker insert 8253-84.            Consisting of 2gang future® linear cover frame 1722-184K.            Rated voltage: 230 V~, +10 % / -10 %            Rated frequency: 50 Hz - 60 Hz            Protection class (Device): IP 20            Temperature range (Device): 5 °C to 40 °C            Dimensions: (L x W x D): 150 mm x 80 mm x 49 mm            Mounting depth: 32 mm</p>	<b>8270 UJ-84-101-500</b>	2CKA008200A0237	1
studio white			

<sup>1)</sup>No claw. Screw-fixing via keyholes.

 <p><b>Busch-Radio iNet <sup>1)</sup> <sup>2)</sup></b>  <b>complete set</b>            Ready-to-install WLAN Internet radio alarm clock for mono operation (set packaged).            Consisting of the Busch-Radio iNet 8216 U.            Consisting of speaker insert 8223 U.            Consisting of the cover plate for the Busch-Radio iNet.            Consisting of cover plate for speaker insert 8253-84.            Consisting of 2gang future® linear cover frame 1722-184K.            Rated voltage: 110 - 230 V~, +10 % / -10 %            Rated frequency: 50 Hz - 60 Hz            Protection class (Device): IP 20            Dimensions: (L x W x D): 150 mm x 80 mm x 50 mm            Mounting depth: 33 mm</p> <p></p>	<b>8240-84-500</b>	2CKA008200A0156	1
studio white			

<sup>1)</sup>No claw. Screw-fixing via keyholes.

<sup>2)</sup>To be mounted only in connection with commercially available flush-mounted installation boxes according to DIN 49073 > 40 mm depth gauge or Busch-Jaeger art. no. 3040, 3050 or 3060.

 <p><b>Loudspeaker insert <sup>1)</sup></b>  <b>5 cm (2")</b>            With flat plug connector.            With broadband characteristics.            Rated output: 2 W (RMS)            Incl. speaker connection cable.            Frequency response: 200 - 20,000 Hz            Impedance: 4 Ohm            Protection class (Device): IP 20, SELV            Mounting depth: 32 mm</p>	<b>8223 U-500</b>	2CKA008200A0183	1/10
--	-------------------	-----------------	------

<sup>1)</sup>No claw. Screw-fixing via keyholes.

Product	Article-No.	Order-No.	Pack/Qty
 <p><b>Busch-powerDock Insert <sup>1)</sup> <sup>2)</sup> <sup>3)</sup> <sup>4)</sup></b>            For charging and supplying mobile terminal devices.            With quick charging function for devices compatible with quick-charge™.            Makes possible fast charging of the mobile terminal device.            Rated voltage: 100 - 230 V~, +10 % / -10 %            Rated frequency: 50 Hz - 60 Hz            Suitable for: Apple terminal device            Rated current: 2.1 A            Output voltage: 5 V-            Suitable for: Terminal device with USB-C connection            Rated current: 2.1 A            Output voltage: 5 V-            Suitable for: Terminal device with quick-charge support and USB-C connection and quick-charge™ function.            Rated current: 2 A            Output voltage: 9 V-            Protection class (Device): IP 20, SELV            Temperature range (Device): 5 °C to 35 °C            Dimensions: (L x W x D): 71 mm x 71 mm x 32 mm            Mounting depth: 32 mm</p>	<b>6473 U-500</b>	2CKA006400A0039	1/10

<sup>1)</sup>No claw. Screw-fixing via keyholes.

<sup>2)</sup>The USB-C connection of the Busch-powerDock uses the quick charging function according to Qualcomm® Quick charge™ 2.0 standard.

<sup>3)</sup>In rare cases the manufacturers of USB-C terminal devices support the quick-charging function independent of this standard only in case of charging devices that are the same as those of other manufacturers.

<sup>4)</sup>In these cases the quick-charging function of the terminal device is not enabled.

 <p><b>Busch-powerDock Charging cradle with Apple lightning connection <sup>1)</sup></b>            For Busch-powerDock insert 6473 U.            For attaching mobile terminal devices with lightning connection.            For iPhone XS Max, iPhone XS, iPhone XR, iPhone X.            For iPhone 8 Plus, iPhone 8.            For iPhone 7 Plus, iPhone 7.            For iPhone SE.            For iPhone 6s Plus, iPhone 6s, iPhone 6 Plus, iPhone 6.            For iPhone 5s, iPhone 5c, iPhone 5.            For iPod touch (6th generation), iPod touch (5th generation), iPod nano (7th generation).            Suitable for use with protective covers certified by Apple.            Temperature range (Device): 5 °C to 35 °C            Dimensions: (L x W x D): 54 mm x 54 mm x 36 mm</p>	<b>6473-500</b>	2CKA006400A0081	1/10
--	-----------------	-----------------	------

<sup>1)</sup>Not released for use with the iPad.

 <p><b>Busch-powerDock Charging cradle with USB-C connection</b>            For Busch-powerDock insert 6473 U.            For attaching mobile terminal devices with USB-C connection.            Temperature range (Device): 5 °C to 35 °C            Dimensions: (L x W x D): 54 mm x 54 mm x 36 mm</p>	<b>6473/11-500</b>	2CKA006400A0083	1/10
--	--------------------	-----------------	------

## Busch-axcent®

### Multimedia / communication adapters

Product	Article-No.	Order-No.	Pack/Qty
 <p><b>USB power adapter insert, flush-mounted <sup>1)</sup> <sup>2)</sup> <sup>3)</sup> <sup>4)</sup></b>            For supply and support of mobile devices via USB-cable.            With two USB type A outputs.            To support two devices at the same time.            With electronic short-circuit protection.            With electronic overload protection.            Rated voltage: 100 - 230 V~, +10 % / -10 %            Secondary: 5 V-, +5 % / -5 %            Rated frequency: 50 Hz - 60 Hz            Suitable for: In case one output is used:            Rated current: 3000 mA            Suitable for: In case two output are used:            Rated current: 1500 mA            Protection class (Device): IP 20, SELV            Temperature range (Device): 0 °C to 35 °C            Dimensions: (L x W x D): 71 mm x 71 mm x 43 mm            Mounting depth: 32 mm</p>	<b>6472 U-500-101</b>	2CKA006400A0094	1

<sup>1)</sup> No claw. Screw-fixing via keyholes.

<sup>2)</sup> No data transfer.

<sup>3)</sup> For terminal devices with standardized charging interface according to DIN EN 62684.



<sup>4)</sup> Use dust cover 2098 when cleaning the device.

 <p><b>USB power adapter insert, flush-mounted <sup>1)</sup> <sup>2)</sup> <sup>3)</sup>            With USB-A &amp; USB-C interface</b>            For supply and support of mobile devices via USB-cable.            With USB type A and USB type C female connector.            To support two devices at the same time.            Supports automatic negotiating of optimum charging parameters for the shortest charging times.            Support of loading protocol on the USB-A connection:            Apple MFI with 2.4 A and BC 1.2 with 1.5 A.            Support of the additional quick-charge protocols:            USB-PD and quick-charge 3.0 &amp; 4.0.            With electronic short-circuit protection.            With electronic overload protection.            Rated voltage: 230 - 230 V~, +10 % / -10 %            Rated frequency: 50 Hz - 60 Hz            Outputs: 2x USB charging interface            Suitable for: Only USB-A bus occupied:            Rated current: 3000 mA            Output voltage: 5 V-            Suitable for: Only USB-C bus occupied:            Rated power: 18 W</p> <p>Suitable for: USB-A and USB-C bus occupied. Total:            Rated current: 3250 mA            Output voltage: 5 V-            Protection class (Device): IP 20, SELV            Temperature range (Device): 0 °C to 35 °C            Dimensions: (L x W x D): 71 mm x 71 mm x 43 mm            Mounting depth: 32 mm</p>	<b>6475 U-500</b>	2CKA006400A0399	1
--	-------------------	-----------------	---

<sup>1)</sup> No claw. Screw-fixing via keyholes.

<sup>2)</sup> No data transfer.

<sup>3)</sup> When cleaning the device, use dust cover 2098 for the USB-A connection.

Product	Article-No.	Order-No.	Pack/Qty
 <p><b>Busch-powerDock complete set with lightning connector <sup>1)</sup> <sup>2)</sup> <sup>3)</sup></b>            Complete set ready to install for charging mobile terminal devices with Apple lightning connection.            Makes possible fast charging of the mobile terminal device.            For iPhone XS Max, iPhone XS, iPhone XR, iPhone X.            For iPhone 8 Plus, iPhone 8.            For iPhone 7 Plus, iPhone 7.            For iPhone SE.            For iPhone 6s Plus, iPhone 6s, iPhone 6 Plus, iPhone 6.            For iPhone 5s, iPhone 5c, iPhone 5.            For iPod touch (6th generation), iPod touch (5th generation), iPod nano (7th generation).            Suitable for use with protective covers certified by Apple.            Consisting of Busch-powerDock insert 6473 U.            Consisting of Busch-powerDock charging cradle with lightning connection 6473.            Consisting of the cover plate for the Busch-powerDock charging cradle.            Consisting of 1gang future® linear cover frames.            Rated voltage: 100 - 230 V~, +10 % / -10 %            Rated frequency: 50 Hz - 60 Hz            Suitable for: Apple terminal device            Rated current: 2.1 A            Output voltage: 5 V-            Protection class (Device): IP 20, SELV            Temperature range (Device): 5 °C to 35 °C            Dimensions: (L x W x D): 81 mm x 81 mm x 74 mm            Mounting depth: 32 mm</p> <p>Made for  </p>	<b>6480-84-500</b>	2CKA006400A0045	1

<sup>1)</sup> No claw. Screw-fixing via keyholes.

<sup>2)</sup> Not released for use with the iPad.

<sup>3)</sup> "Made for iPod" and "Made for iPhone" means that an electronic accessory has been specially designed for connection to an iPod or iPhone and meets the respective Apple performance specifications that have been confirmed by the designer.

Apple is not responsible for the function of this device or its conformity with safety standards and regulatory standards.

## Busch-axcent®

### Multimedia / communication adapters

Product	Article-No.	Order-No.	Pack/Qty
 <p><b>Busch-powerDock Complete set with USB-C connection <sup>1)</sup> <sup>2)</sup> <sup>3)</sup> <sup>4)</sup></b>            Complete set ready to install for charging mobile terminal devices with USB-C connection.            With quick charging function for devices compatible with quick-charge™.            Makes possible fast charging of the mobile terminal device.            Consisting of Busch-powerDock insert 6473 U.            Consisting of Busch-powerDock charging cradle with USB-C connection 6473/11.            Consisting of the cover plate for the Busch-powerDock charging cradle.            Consisting of 1gang future® linear cover frames.            Rated voltage: 100 - 230 V~, +10 % / -10 %            Rated frequency: 50 Hz - 60 Hz            Suitable for: Terminal device with USB-C connection            Rated current: 2.1 A            Output voltage: 5 V-            Suitable for: Terminal device with quick-charge support and USB-C connection and quick-charge™ function.            Rated current: 2 A            Output voltage: 9 V-            Protection class (Device): IP 20, SELV            Temperature range (Device): 5 °C to 35 °C            Dimensions: (L x W x D): 81 mm x 81 mm x 74 mm            Mounting depth: 32 mm</p>	<b>6480/11-84-500</b>	2CKA006400A0047	1
studio white	<b>6480/11-84-500</b>	2CKA006400A0047	1

<sup>1)</sup> No claw. Screw-fixing via keyholes.

<sup>2)</sup> The USB-C connection of the Busch-powerDock uses the quick charging function according to Qualcomm® Quick charge™ 2.0 standard.

<sup>3)</sup> In rare cases the manufacturers of USB-C terminal devices support the quick-charging function independent of this standard only in case of charging devices that are the same as those of other manufacturers.

<sup>4)</sup> In these cases the quick-charging function of the terminal device is not enabled.

 <p><b>HDMI connection unit <sup>1)</sup> with screw-type terminals and strain relief</b>            Suitable for telephone connection unit cover plates 2539-21x and 1766-xxx.            To link high-definition digital audio and video data from e.g. SAT-receiver, DVD-/Blue-Ray-player to plasma-type, LCD- or-LED-TVs/screens.            HDMI-type A, 3D-compatible.            Fully HD ready (1920 x 1080 pixel).            For 20-wire HDMI-cables via screw-type terminals.            For trunk systems, flush-mounted wall boxes and underfloor systems.            For easy mounting and adhering to the admissible bending radii, the Kaiser &gt;Electronic socket&lt;, article number 1068-02 or 9062-74, is recommended.            Without cover plate.            Without claws.            Protection class (Device): IP 20            Mounting depth: 34 mm</p>	<b>0261/31-500</b>	2CKA000230A0430	1
white	<b>0261/31-500</b>	2CKA000230A0430	1
grey	<b>0261/33-500</b>	2CKA000230A0432	1
alpine white	<b>0261/32-500</b>	2CKA000230A0431	1

<sup>1)</sup> Please follow the recommendations of the cable and device producers for the max. HDMI cable lengths.

Product	Article-No.	Order-No.	Pack/Qty
 <p><b>VGA connection unit <sup>1)</sup> with screw-type terminals and strain relief</b>            Suitable for telephone connection unit cover plates 2539-21x and 1766-xxx.            To link analogue video data between PCs and laptops to monitors or digital projectors etc.            VGA-type: D-type, 15-pole.            Fully HD ready (1920 x 1080 pixel).            For 15-wire VGA-cables via screw-type terminals.            For trunk systems, flush-mounted wall boxes and underfloor systems.            For easy mounting and adhering to the admissible bending radii, the Kaiser &gt;Electronic socket&lt;, article number 1068-02 or 9062-74, is recommended.            Without cover plate.            Without claws.            Protection class (Device): IP 20            Mounting depth: 34 mm</p>	<b>0261/21-500</b>	2CKA000230A0424	1
white	<b>0261/21-500</b>	2CKA000230A0424	1
grey	<b>0261/23-500</b>	2CKA000230A0426	1
alpine white	<b>0261/22-500</b>	2CKA000230A0425	1

<sup>1)</sup> Please follow the recommendations of the cable and device producers for the max. VGA cable lengths.







 <p><b>USB connection unit <sup>1)</sup> with screw-type terminals and strain relief</b>            Suitable for telephone connection unit cover plates 2539-21x and 1766-xxx.            To link mobile devices like e.g. printer, scanner, USB-sticks or digital cameras etc.            USB-type A, USB 2.0 compatible.            For 5-wire USB- cables via screw-type terminals.            For trunk systems, flush-mounted wall boxes and underfloor systems.            For easy mounting and adhering to the admissible bending radii, the Kaiser &gt;Electronic socket&lt;, article number 1068-02 or 9062-74, is recommended.            Without cover plate.            Without claws.            Protection class (Device): IP 20            Mounting depth: 34 mm</p>	<b>0261/11-500</b>	2CKA000230A0418	1
white	<b>0261/11-500</b>	2CKA000230A0418	1
grey	<b>0261/13-500</b>	2CKA000230A0420	1
alpine white	<b>0261/12-500</b>	2CKA000230A0419	1



<sup>1)</sup> Please follow the recommendations of the cable and device producers for the max. USB cable lengths.

 <p><b>Communication adapter for BNC-F Duct-jacks</b>            Suitable for telephone connection unit cover plates 2539-21x and 1766-xxx.            To support 1 or 2 jacks.            For trunk systems, flush-mounted wall boxes and underfloor systems.            Without cover plate.            Without claws.            Protection class (Device): IP 20</p>	<b>0262/11-500</b>	2CKA000230A0436	1
white	<b>0262/11-500</b>	2CKA000230A0436	1
grey	<b>0262/13-500</b>	2CKA000230A0438	1
alpine white	<b>0262/12-500</b>	2CKA000230A0437	1

## Busch-axcent®

### Multimedia / communication adapters

Product	Article-No.	Order-No.	Pack/Qty
	<b>F duct-jack for communication adapter</b> For connection of antenna cables e.g.. for TVs with integrated TV-tuner and satellite receiver. With screw-type terminals. For trunk systems, flush-mounted wall boxes and underfloor systems. Protection class (Device): IP 20		
metal clad	<b>0262-500</b>	2CKA000230A0440	1
	<b>Communication adapter for Cinch-jacks</b> Suitable for telephone connection unit cover plates 2539-21x and 1766-xxx. To support 1 or 2 jacks. For trunk systems, flush-mounted wall boxes and underfloor systems. Without cover plate. Without claws. Protection class (Device): IP 20		
white	<b>0263/11-500</b>	2CKA000230A0444	1
grey	<b>0263/13-500</b>	2CKA000230A0446	1
alpine white	<b>0263/12-500</b>	2CKA000230A0445	1
	<b>Cinch-jacks for communication adapter</b> To link analogue audio devices like audio-receiver, amplifier and HiFi-sets. Audio-band 20Hz - 20kHz. Marked white: audio , channel left. With soldering tag. Protection class (Device): IP 20		
alpine white	<b>0263/04-500</b>	2CKA000230A0451	1
	<b>Cinch-jacks for communication adapter</b> To link analogue audio devices like audio-receiver, amplifier and HiFi-sets. Audio-band 20Hz - 20kHz. Marked black: audio , channel left. With soldering tag. Protection class (Device): IP 20		
black	<b>0263/05-500</b>	2CKA000230A0452	1
	<b>Cinch-jacks for communication adapter</b> To link analogue audio devices like audio-receiver, amplifier and HiFi-sets. Audio-band 20Hz - 20kHz. Marked red: audio , channel left. With soldering tag. Protection class (Device): IP 20		
Red	<b>0263/06-500</b>	2CKA000230A0453	1
	<b>Cinch-jacks for communication adapter</b> For connecting analogue video devices, such as DVD players, hard disc recorders, video recorders or receivers. Marked yellow: audio , channel left. With soldering tag. Protection class (Device): IP 20		
yellow	<b>0263/07-500</b>	2CKA000230A0454	1

Product	Article-No.	Order-No.	Pack/Qty
	<b>Communication adapter for Mini-jacks 3,5mm.</b> Suitable for telephone connection unit cover plates 2539-21x and 1766-xxx. To support 1 or 2 jacks. For trunk systems, flush-mounted wall boxes and underfloor systems. Without cover plate. Without claws. Protection class (Device): IP 20		
white	<b>0264/11-500</b>	2CKA000230A0458	1
grey	<b>0264/13-500</b>	2CKA000230A0460	1
alpine white	<b>0264/12-500</b>	2CKA000230A0459	1
	<b>Mini-jack 3,5 mm for communication adapter</b> For the connection of mobile terminal devices such as MP3 player (stereo), mobile telephone and smartphones. Audio-band 20Hz - 20kHz. With soldering tag. Protection class (Device): IP 20		
chrome gloss	<b>0264-500</b>	2CKA000230A0462	1
	<b>Stereo loudspeaker connection box 1)</b> With screwless terminals (with screw-type terminals on the back). With 4 terminals. Cable cross-section max. 10 mm <sup>2</sup> . Polarity is indicated by color. With claw. Protection class (Device): IP 20		
white	<b>0248/02-101</b>	2CKA000230A0402	10/100
<sup>1)</sup> Suitable for cover telephone unit 1766-xxx and 2539-21x.			
	<b>Stereo loudspeaker connection box 1)</b> With screwless terminals (with screw-type terminals on the back). With 4 terminals. Cable cross-section max. 10 mm <sup>2</sup> . Polarity is indicated by color. With claw. Protection class (Device): IP 20		
<sup>1)</sup> Suitable for cover telephone unit 1766-xxx and 2539-21x.			
	<b>Stereo loudspeaker connection box 1)</b> With screwless terminals (with screw-type terminals on the back). With 4 terminals. Cable cross-section max. 10 mm <sup>2</sup> . Polarity is indicated by color. With claw. Protection class (Device): IP 20		
anthracite	<b>0248/05-101</b>	2CKA000230A0404	10/100
<sup>1)</sup> Suitable for cover telephone unit 1766-xxx and 2539-21x.			

## Busch-axcent®

### Multimedia / communication adapters

Product	Article-No.	Order-No.	Pack/Qty
	<b>Cover plate</b> For Busch-Radio DAB+ 8215 U-101. For Busch-Radio BTconnect DAB+ 8217 U-101. For Busch-Radio iNet 8216 U.		
anthracite	<b>8252-81-101-500</b>	2CKA008200A0249	10
aluminium silver <sup>1)</sup>	<b>8252-83-101-500</b>	2CKA008200A0253	10
studio white	<b>8252-84-101-500</b>	2CKA008200A0255	10
grey metallic <sup>1)</sup>	<b>8252-803-101-500</b>	2CKA008200A0257	10
studio white matt <sup>1)</sup>	<b>8252-884-101-500</b>	2CKA008200A0259	10
black matt <sup>1)</sup>	<b>8252-885-101-500</b>	2CKA008200A0261	10

<sup>1)</sup>Surface painted.

	<b>Cover plate</b> For loudspeaker insert 8223 U.		
anthracite	<b>8253-81</b>	2CKA008200A0078	1/10
aluminium silver <sup>1)</sup>	<b>8253-83</b>	2CKA008200A0080	1/10
studio white	<b>8253-84</b>	2CKA008200A0081	1/10
grey metallic <sup>1)</sup>	<b>8253-803</b>	2CKA008200A0115	1/10
studio white, matt <sup>1)</sup>	<b>8253-884</b>	2CKA008200A0123	1/10
black matt <sup>1)</sup>	<b>8253-885</b>	2CKA008200A0126	1/10

<sup>1)</sup>Surface painted.

	<b>Cover plate</b> For telephone connection unit. For USB, VGA, HDMI inserts and communication adapter. USB power adapter insert 6472 U. For loudspeaker connection box. Suitable for part number 0248/0x-101. For data modules. Suitable for Art. No. 0219/12 and 0219/13. For modular outlets with 90° RJ45 outlet from Telegärtner (type MJ and WE). Protection class (Device): IP 20		
anthracite	<b>1766-81</b>	2CKA001710A3613	10
aluminium silver <sup>1)</sup>	<b>1766-83</b>	2CKA001710A3659	10/100
studio white	<b>1766-84-500</b>	2CKA001710A3992	10/100
grey metallic <sup>1)</sup>	<b>1766-803</b>	2CKA001710A3854	10
studio white, matt <sup>1)</sup>	<b>1766-884</b>	2CKA001710A3926	10
black matt <sup>1)</sup>	<b>1766-885</b>	2CKA001710A3903	10

<sup>1)</sup>Surface painted.

Product	Article-No.	Order-No.	Pack/Qty
	<b>Cover plate with metal mounting plate</b> With fixing claws. loudspeaker inserts and cover. With soldering tag. For covering universal data communication connectors and circular connectors with screwed plug M 16x0.75 (installable in insert) in accordance with DIN 41524, 41529, 45322, 45327, 45328 and 45329. Protection class (Device): IP 20		
anthracite	<b>1751-81</b>	2CKA001723A0253	10
aluminium silver <sup>1)</sup>	<b>1751-83</b>	2CKA001723A0254	10
studio white	<b>1751-84</b>	2CKA001723A0240	10/100
grey metallic <sup>1)</sup>	<b>1751-803</b>	2CKA001723A0257	10
studio white, matt <sup>1)</sup>	<b>1751-884</b>	2CKA001710A3880	1
black matt <sup>1)</sup>	<b>1751-885</b>	2CKA001723A0259	10

<sup>1)</sup>Surface painted.

	<b>Cover plate with rotary control, with marking</b> As a cover for volume controllers. Suitable for the >LR mono BJ FM< devices of WHD. Protection class (Device): IP 20		
anthracite	<b>1740 DR/03-81</b>	2CKA001710A4120	10
aluminium silver <sup>1)</sup>	<b>1740 DR/03-83</b>	2CKA001710A3811	10
studio white	<b>1740 DR/03-84</b>	2CKA001710A3808	10
grey metallic <sup>1)</sup>	<b>1740 DR/03-803</b>	2CKA001710A4119	10
studio white, matt <sup>1)</sup>	<b>1740 DR/03-884</b>	2CKA001710A3870	10
black matt <sup>1)</sup>	<b>1740 DR/03-885</b>	2CKA001710A3892	10

<sup>1)</sup>Surface painted.

	<b>Cover plate for Busch-powerDock</b> For Busch-powerDock charging cradle.		
anthracite	<b>6477-81</b>	2CKA006400A0056	10
aluminium silver <sup>1)</sup>	<b>6477-83</b>	2CKA006400A0058	10
studio white	<b>6477-84</b>	2CKA006400A0059	10/100
grey metallic <sup>1)</sup>	<b>6477-803</b>	2CKA006400A0060	10
studio white, matt <sup>1)</sup>	<b>6477-884</b>	2CKA006400A0062	10
black matt <sup>1)</sup>	<b>6477-885</b>	2CKA006400A0063	10

<sup>1)</sup>Surface painted.

## Busch-axcent®

### Room thermostats

Product	Article-No.	Order-No.	Pack/Qty
	<b>Room thermostat, flush-mounted<sup>1) 2) 3)</sup></b> Switch contact opens when the set temperature is reached. With fixing claws. Separate terminal to activate nighttime mode and reduction of room temperature by 4K. Class of temperature controller 1 Contribution to space heating energy efficiency 1,0%. Rated voltage: 230 V~ Rated current: 10 A Temperature range (Device): 5 °C to 30 °C Dimensions: (L x W x D): 71 mm x 71 mm x 52 mmEN 60730-2-9, British Standard EN 60669-2-1		
	<b>1094 U-500</b>	2CKA001032A0512	1/10
<b>Mounting boxes:</b>	35 mm deep flush 1gang or Dual Box 3070-2/35 BSDB.		
<b>2gang product combinations:</b>	2gang combination with adapter plate APBS in Dual Box only.		

<sup>1)</sup> Only in conjunction with standard flush-mounting boxes according to DIN 49073, erect or Busch-Jaeger No. 3040 wallbox stonework, 3050 wallbox cavity wall or 3060 wallbox concrete)

<sup>2)</sup> Servo-valves, "closed when de-energized", are necessary for connection to thermostat. e.g. Article No. 6164/10-, see KNX chapter.

<sup>3)</sup> Switching temperature difference:  $\pm 0.5$  K.

	<b>Room thermostat, flush-mounted<sup>1) 2) 3)</sup></b> <b>Slide switch</b> With built-in slide switch and control lamp for nightly reduction of 4 K. Switch contact opens when the set temperature is reached. With fixing claws. Separate terminal to activate nighttime mode and reduction of room temperature by 4K. Class of temperature controller 1 Contribution to space heating energy efficiency 1,0%. Rated voltage: 230 V~ Rated current: 10 A Temperature range (Device): 5 °C to 30 °C Dimensions: (L x W x D): 71 mm x 71 mm x 52 mmEN 60730-2-9, British Standard EN 60669-2-1		
	<b>1095 U-500</b>	2CKA001032A0514	1/10
<b>Mounting boxes:</b>	35 mm deep flush 1gang or Dual Box 3070-2/35 BSDB.		
<b>2gang product combinations:</b>	2gang combination with adapter plate APBS in Dual Box only.		

<sup>1)</sup> Only in conjunction with standard flush-mounting boxes according to DIN 49073, erect or Busch-Jaeger No. 3040 wallbox stonework, 3050 wallbox cavity wall or 3060 wallbox concrete)

<sup>2)</sup> Servo-valves, "closed when de-energized", are necessary for connection to thermostat. e.g. Article No. 6164/10-, see KNX chapter.

<sup>3)</sup> Switching temperature difference:  $\pm 0.5$  K.

Product	Article-No.	Order-No.	Pack/Qty
	<b>Room thermostat, flush-mounted<sup>1) 2) 3)</sup></b> <b>Sliding switch, 24 V</b> With built-in slide switch and control lamp for nightly reduction of 4 K. Switch contact opens when the set temperature is reached. With fixing claws. Separate terminal to activate nighttime mode and reduction of room temperature by 4K. Class of temperature controller 1 Contribution to space heating energy efficiency 1,0%. Rated voltage: 24 V~ Rated current: 1 A Temperature range (Device): 5 °C to 30 °C Dimensions: (L x W x D): 71 mm x 71 mm x 52 mmEN 60730-2-9, British Standard EN 60669-2-1		
	<b>1096 U</b>	2CKA001032A0485	1
<b>Mounting boxes:</b>	35 mm deep flush 1gang or Dual Box 3070-2/35 BSDB.		
<b>2gang product combinations:</b>	2gang combination with adapter plate APBS in Dual Box only.		

<sup>1)</sup> Only in conjunction with standard flush-mounting boxes according to DIN 49073, erect or Busch-Jaeger No. 3040 wallbox stonework, 3050 wallbox cavity wall or 3060 wallbox concrete)

<sup>2)</sup> Servo-valves, "closed when de-energized", are necessary for connection to thermostat, e.g., Art. No. 6164/10 .

<sup>3)</sup> Switching temperature difference:  $\pm 0.5$  K.

	<b>Room thermostat, flush-mounted<sup>1) 2) 3)</sup></b> <b>1gang 2way</b> With fixing claws. Class of temperature controller 1 Contribution to space heating energy efficiency 1,0%. Rated voltage: 230 V~ Rated current: 5 A Temperature range (Device): 5 °C to 30 °C Dimensions: (L x W x D): 71 mm x 71 mm x 52 mmEN 60730-2-9, British Standard EN 60669-2-1		
	<b>1097 U-500</b>	2CKA001032A0513	1/10
<b>Mounting boxes:</b>	35 mm deep flush 1gang or Dual Box 3070-2/35 BSDB.		
<b>2gang product combinations:</b>	2gang combination with adapter plate APBS in Dual Box only.		

<sup>1)</sup> Only in conjunction with standard flush-mounting boxes according to DIN 49073, erect or Busch-Jaeger No. 3040 wallbox stonework, 3050 wallbox cavity wall or 3060 wallbox concrete)

<sup>2)</sup> Servo valves of "closed or open when de-energized" design are required for the controller. E.g. article no. 6164/10-101.

<sup>3)</sup> Switching temperature difference:  $\pm 0.5$  K.

## Busch-axcent®

### Room thermostats

Product	Article-No.	Order-No.	Pack/Qty
 <p><b>Room thermostat, flush-mounted <sup>1)</sup> <sup>2)</sup> <sup>3)</sup></b>  <b>Actual value indication</b>            With actual value temperature display            Automatic controller calibration            Switch contact opens when the set temperature is reached.            With fixing claws.            Separate terminal to activate nighttime mode and reduction of room temperature by 4K.            Class of temperature controller 1            Contribution to space heating energy efficiency 1,0%.            Rated voltage: 230 V~            Rated current: 10 A            Temperature range (Device): 5 °C to 30 °C            Dimensions: (L x W x D): 71 mm x 71 mm x 52 mmEN            60730-2-9, British Standard EN 60669-2-1</p>	<b>1094 UTA</b>	2CKA001032A0487	1/10

<sup>1)</sup> Only in conjunction with standard flush-mounting boxes according to DIN 49073, erect or Busch-Jaeger No. 3040 wallbox stonework, 3050 wallbox cavity wall or 3060 wallbox concrete)

<sup>2)</sup> Servo-valves, "closed when de-energized", are necessary for connection to thermostat. e.g. Article No. 6164/10-, see KNX chapter.

<sup>3)</sup> Switching temperature difference:  $\pm 0.5$  K.

 <p><b>Room thermostat, flush-mounted <sup>1)</sup> <sup>2)</sup> <sup>3)</sup></b>  <b>Sliding switch, actual value indication</b>            With actual value temperature display            Automatic controller calibration            Switch contact opens when the set temperature is reached.            With built-in slide switch and control lamp for nightly reduction of 4 K.            With fixing claws.            Separate terminal to activate nighttime mode and reduction of room temperature by 4K.            Class of temperature controller 1            Contribution to space heating energy efficiency 1,0%.            Rated voltage: 230 V~            Rated current: 10 A            Temperature range (Device): 5 °C to 30 °C            Dimensions: (L x W x D): 71 mm x 71 mm x 52 mmEN            60730-2-9, British Standard EN 60669-2-1</p>	<b>1095 UTA</b>	2CKA001032A0488	1/10
---	-----------------	-----------------	------

<sup>1)</sup> Only in conjunction with standard flush-mounting boxes according to DIN 49073, erect or Busch-Jaeger No. 3040 wallbox stonework, 3050 wallbox cavity wall or 3060 wallbox concrete)

<sup>2)</sup> Servo-valves, "closed when de-energized", are necessary for connection to thermostat. e.g. Article No. 6164/10-, see KNX chapter.

<sup>3)</sup> Switching temperature difference:  $\pm 0.5$  K.

Product	Article-No.	Order-No.	Pack/Qty
 <p><b>Room thermostat, flush-mounted <sup>1)</sup> <sup>2)</sup> <sup>3)</sup></b>  <b>Sliding switch, actual value indication, 24 V</b>            With actual value temperature display            Automatic controller calibration            Switch contact opens when the set temperature is reached.            With built-in slide switch and control lamp for nightly reduction of 4 K.            With fixing claws.            Separate terminal to activate nighttime mode and reduction of room temperature by 4K.            Class of temperature controller 1            Contribution to space heating energy efficiency 1,0%.            Rated voltage: 24 V~            Rated current: 1 A            Temperature range (Device): 5 °C to 30 °C            Dimensions: (L x W x D): 71 mm x 71 mm x 52 mmEN            60730-2-9, British Standard EN 60669-2-1</p>	<b>1096 UTA</b>	2CKA001032A0489	1/10

<sup>1)</sup> Only in conjunction with standard flush-mounting boxes according to DIN 49073, erect or Busch-Jaeger No. 3040 wallbox stonework, 3050 wallbox cavity wall or 3060 wallbox concrete)

<sup>2)</sup> Servo-valves, "closed when de-energized", are necessary for connection to thermostat, e.g., Art. No. 6164/10 .

<sup>3)</sup> Switching temperature difference:  $\pm 0.5$  K.

 <p><b>Room thermostat, flush-mounted <sup>1)</sup> <sup>2)</sup> <sup>3)</sup></b>  <b>Change-over contact, actual value indication</b>            With actual value temperature display            Automatic controller calibration            With fixing claws.            Class of temperature controller 1            Contribution to space heating energy efficiency 1,0%.            Rated voltage: 230 V~            Rated current: 5 A            Dimensions: (L x W x D): 71 mm x 71 mm x 52 mmEN            60730-2-9, British Standard EN 60669-2-1</p>	<b>1097 UTA</b>	2CKA001032A0490	1/10
---	-----------------	-----------------	------

<sup>1)</sup> Only in conjunction with standard flush-mounting boxes according to DIN 49073, erect or Busch-Jaeger No. 3040 wallbox stonework, 3050 wallbox cavity wall or 3060 wallbox concrete)

<sup>2)</sup> Servo valves of "closed or open when de-energized" design are required for the controller. E.g. article no. 6164/10-101.

<sup>3)</sup> Switching temperature difference:  $\pm 0.5$  K.

 <p><b>Room thermostat, flush-mounted <sup>1)</sup> <sup>2)</sup> <sup>3)</sup></b>  <b>Change-over contact, setpoint indication, timer</b>            With change-over contact.            Easy adjustment using menu and text-based display.            4 switching times per day can be user-defined for each day of the week.            With fixing claws.            Automatic summer/wintertime switch-over            Power reserve &gt; 10 hours.            To fit cover plate 6435-xxx.            Class of temperature controller 1            Contribution to space heating energy efficiency 1,0%.            Rated voltage: 230 V~            Rated current: 10 A            Temperature range (Device): 5 °C to 30 °C            Dimensions: (L x W x D): 71 mm x 71 mm x 52 mmEN            60730-2-9</p>	<b>1098 U-101</b>	2CKA001032A0508	1/10
---	-------------------	-----------------	------

<sup>1)</sup> Only in conjunction with standard flush-mounting boxes according to DIN 49073, erect or Busch-Jaeger No. 3040 wallbox stonework, 3050 wallbox cavity wall or 3060 wallbox concrete)

<sup>2)</sup> Servo valves of "closed or open when de-energized" design are required for the controller. E.g. article no. 6164/10-101.

<sup>3)</sup> Switching temperature difference:  $\pm 0.5$  K.

## Busch-axcent®

### Room thermostats

Product	Article-No.	Order-No.	Pack/Qty
 <p><b>Room thermostat, flush-mounted <sup>1)</sup></b>  <b>Remote sensor</b>            With remote sensor and thermal feedback            For underfloor heating.            With built-in slide switch and control lamp for nightly reduction of 4 K.            Switch contact opens when the set temperature is reached.            With fixing claws.            Remote sensor cable length: 4 m.            Sensor =NTC, 10 kilo-ohm at 25 degrees C.            Adjusting range: +10 to +50° C.            Connecting cable: 1mm<sup>2</sup> to 2.5 mm<sup>2</sup>            Separate terminal to activate nighttime mode and reduction of room temperature by 4K.            Class of temperature controller 1            Contribution to space heating energy efficiency 1,0%.            Rated voltage: 230 V~            Rated current: 16 A, cos φ 1            Dimensions: (L x W x D): 71 mm x 71 mm x 52 mmEN 60730-2-9, British Standard EN 60669-2-1</p>	<b>1095 UF</b>	2CKA001032A0497	1/10

<sup>1)</sup> Only in conjunction with standard flush-mounting boxes according to DIN 49073, erect or Busch-Jaeger No. 3040 wallbox stonework, 3050 wallbox cavity wall or 3060 wallbox concrete)

 <p><b>Room thermostat, flush-mounted <sup>1)</sup> <sup>2)</sup></b>  <b>Change-over contact, setpoint indication, timer, remote sensor</b>            With change-over contact.            Easy adjustment using menu and text-based display.            4 switching times per day can be user-defined for each day of the week.            With fixing claws.            Automatic summer/wintertime switch-over            Remote sensor cable length: 4 m.            Sensor =NTC, 10 kilo-ohm at 25 degrees C.            Power reserve &gt; 10 hours            To fit cover plate 6435-xxx.            Class of temperature controller 1            Contribution to space heating energy efficiency 1,0%.            Rated voltage: 230 V~            Rated current: 16 A            Temperature range (Device): 10 °C to 50 °C            Dimensions: (L x W x D): 71 mm x 71 mm x 52 mmEN 60730-2-9</p>	<b>1098 UF-101</b>	2CKA001032A0509	1/10
--	--------------------	-----------------	------

<sup>1)</sup> Only in conjunction with standard flush-mounting boxes according to DIN 49073, erect or Busch-Jaeger No. 3040 wallbox stonework, 3050 wallbox cavity wall or 3060 wallbox concrete)

<sup>2)</sup> Servo valves of "closed or open when de-energized" design are required for the controller. E.g. article no. 6164/10-101.

Product	Article-No.	Order-No.	Pack/Qty
 <p><b>Room thermostat, flush-mounted <sup>1)</sup> <sup>2)</sup> <sup>3)</sup></b>  <b>Heating/cooling</b>            With separate connection (230 V~) for external switchover between heating or cooling.            Switch contact opens when the set temperature is reached.            With fixing claws.            Nominal current: 10 A heating            Nominal current: 5 A cooling            Class of temperature controller 1            Contribution to space heating energy efficiency 1,0%.            Rated voltage: 230 V~            Temperature range (Device): 5 °C to 30 °C            Dimensions: (L x W x D): 12 mmEN 60730-2-9, British Standard EN 60669-2-1</p>	<b>1099 UHK</b>	2CKA001032A0515	1/10

<sup>1)</sup> Only in conjunction with standard flush-mounting boxes according to DIN 49073, erect or Busch-Jaeger No. 3040 wallbox stonework, 3050 wallbox cavity wall or 3060 wallbox concrete)

<sup>2)</sup> Servo-valves, "closed when de-energized", are necessary for connection to thermostat. e.g. Article No. 6164/10-, see KNX chapter.

<sup>3)</sup> Switching temperature difference: ± 0.5 K.

 <p><b>Room thermostat, flush-mounted <sup>1)</sup> <sup>2)</sup> <sup>3)</sup></b>  <b>Heating/cooling, sliding switch</b>            With built-in sliding switch for switchover between cooling or heating.            Switch contact opens when the set temperature is reached.            With fixing claws.            Nominal current: 10 A heating            Nominal current: 5 A cooling            Class of temperature controller 1            Contribution to space heating energy efficiency 1,0%.            Rated voltage: 230 V~            Temperature range (Device): 5 °C to 30 °C            Dimensions: (L x W x D): 12 mmEN 60730-2-9, British Standard EN 60669-2-1</p>	<b>1099 UHKEA</b>	2CKA001032A0516	1/10
--	-------------------	-----------------	------

<sup>1)</sup> Only in conjunction with standard flush-mounting boxes according to DIN 49073, erect or Busch-Jaeger No. 3040 wallbox stonework, 3050 wallbox cavity wall or 3060 wallbox concrete)

<sup>2)</sup> Servo-valves, "closed when de-energized", are necessary for connection to thermostat. e.g. Article No. 6164/10-, see KNX chapter.

<sup>3)</sup> Switching temperature difference: ± 0.5 K.

	Article-No.	Order-No.	Pack/Qty
 <p><b>Cover plate for room thermostat</b>            For room thermostats 1094 U, 1097 U.</p>			
anthracite	<b>1794-81</b>	2CKA001710A3629	10
aluminium silver <sup>1)</sup>	<b>1794-83</b>	2CKA001710A3668	10
studio white	<b>1794-84</b>	2CKA001710A3544	10
grey metallic <sup>1)</sup>	<b>1794-803</b>	2CKA001710A3847	10
studio white, matt <sup>1)</sup>	<b>1794-884</b>	2CKA001710A3884	10
black matt <sup>1)</sup>	<b>1794-885</b>	2CKA001710A3907	10

<sup>1)</sup> Surface painted.



## Busch-axcent®

### Room thermostats

Product	Article-No.	Order-No.	Pack/Qty
	<b>Cover plate for room thermostat</b> With sliding switch for nightly room temperature reduction. to activate nighttime mode and reduction of room temperature by 4K, for thermostats 1095 U, 1096 U and 1095 UF.		
anthracite	<b>1795-81</b>	2CKA001710A3630	10
aluminium silver <sup>1)</sup>	<b>1795-83</b>	2CKA001710A3669	10
studio white	<b>1795-84</b>	2CKA001710A3569	10
grey metallic <sup>1)</sup>	<b>1795-803</b>	2CKA001710A3848	10
studio white, matt <sup>1)</sup>	<b>1795-884</b>	2CKA001710A3886	10
black matt <sup>1)</sup>	<b>1795-885</b>	2CKA001710A3909	10

<sup>1)</sup>Surface painted.

	<b>Cover plate for room thermostat</b> For room thermostats 1094 UTA, 1097 UTA.		
anthracite	<b>1794 TA-81</b>	2CKA001710A3695	10
aluminium silver <sup>1)</sup>	<b>1794 TA-83</b>	2CKA001710A3697	10
studio white	<b>1794 TA-84</b>	2CKA001710A3698	10
grey metallic <sup>1)</sup>	<b>1794 TA-803</b>	2CKA001710A3849	10
studio white, matt <sup>1)</sup>	<b>1794 TA-884</b>	2CKA001710A3883	10
black matt <sup>1)</sup>	<b>1794 TA-885</b>	2CKA001710A3906	10

<sup>1)</sup>Surface painted.

	<b>Cover plate for room thermostat</b> With sliding switch for nightly room temperature reduction. For room thermostats 1095 UTA, 1096 UTA.		
anthracite	<b>1795 TA-81</b>	2CKA001710A3722	10
aluminium silver <sup>1)</sup>	<b>1795 TA-83</b>	2CKA001710A3724	10
studio white	<b>1795 TA-84</b>	2CKA001710A3725	10
grey metallic <sup>1)</sup>	<b>1795 TA-803</b>	2CKA001710A3850	10
studio white, matt <sup>1)</sup>	<b>1795 TA-884</b>	2CKA001710A3885	10
black matt <sup>1)</sup>	<b>1795 TA-885</b>	2CKA001710A3908	10

<sup>1)</sup>Surface painted.

Product	Article-No.	Order-No.	Pack/Qty
	<b>Cover plate</b> For comfort timer control element 6455-101-500. For standard timer control element 6456-101. For room thermostats 1098 U-101 and 1098 UF-101. For short-time timer 6465 U-101. For Busch-CO2 sensor 1091 U-500. For blind compact timer 6422 U.		
anthracite	<b>6435-81</b>	2CKA006430A0303	10
aluminium silver <sup>1)</sup>	<b>6435-83</b>	2CKA006430A0305	10
studio white	<b>6435-84</b>	2CKA006430A0306	10
grey metallic <sup>1)</sup>	<b>6435-803</b>	2CKA006430A0351	10
studio white, matt <sup>1)</sup>	<b>6435-884</b>	2CKA006430A0388	10
black matt <sup>1)</sup>	<b>6435-885</b>	2CKA006430A0389	10

<sup>1)</sup>Surface painted.

	<b>Cover plate for room thermostat</b> For room temperature controller 1099 UHK.		
anthracite	<b>1795 HK-81</b>	2CKA001710A4013	10
aluminium silver <sup>1)</sup>	<b>1795 HK-83</b>	2CKA001710A4016	10
studio white	<b>1795 HK-84</b>	2CKA001710A4017	10
grey metallic <sup>1)</sup>	<b>1795 HK-803</b>	2CKA001710A4012	10
studio white, matt <sup>1)</sup>	<b>1795 HK-884</b>	2CKA001710A4019	10
black matt <sup>1)</sup>	<b>1795 HK-885</b>	2CKA001710A4020	10

<sup>1)</sup>Surface painted.

	<b>Cover plate for room thermostat</b> For room temperature controller 1099 UHKEA. With sliding switch for switchover between cooling or heating.		
anthracite	<b>1795 HKEA-81</b>	2CKA001710A4045	10
aluminium silver <sup>1)</sup>	<b>1795 HKEA-83</b>	2CKA001710A4048	10
studio white	<b>1795 HKEA-84</b>	2CKA001710A4049	10
grey metallic <sup>1)</sup>	<b>1795 HKEA-803</b>	2CKA001710A4044	10
studio white, matt <sup>1)</sup>	<b>1795 HKEA-884</b>	2CKA001710A4051	10
black matt <sup>1)</sup>	<b>1795 HKEA-885</b>	2CKA001710A4052	10

<sup>1)</sup>Surface painted.

## Busch-axcent®

### LED light

Product	Article-No.	Order-No.	Pack/Qty
---------	-------------	-----------	----------



#### Cover plate <sup>1)</sup> <sup>2)</sup>

As cover for flush-mounted info light.  
For insert 2062 U.  
Size of information field 43 x 43 mm.  
Protection class (Device): IP 20

anthracite	<b>1716-81</b>	2CKA001731A1921	1
aluminium silver <sup>3)</sup>	<b>1716-83</b>	2CKA001731A1950	1
studio white	<b>1716-84</b>	2CKA001731A1923	1
grey metallic <sup>3)</sup>	<b>1716-803</b>	2CKA001731A1976	1
studio white, matt <sup>3)</sup>	<b>1716-884</b>	2CKA001731A1978	1
black matt <sup>3)</sup>	<b>1716-885</b>	2CKA001731A1980	1

<sup>1)</sup> Included with the cover are 46 different text labels and symbols.

<sup>2)</sup> For compatible lettering software, visit [www.BUSCH-JAEGER-labelingtool.com](http://www.BUSCH-JAEGER-labelingtool.com).

<sup>3)</sup> Surface painted.



#### Cover plate for indication lamp

For insert 2061/2661 U.  
As cover for flush-mounted light signal.  
Protection class (Device): IP 20

anthracite	<b>1756-81</b>	2CKA001753A0089	10
aluminium silver <sup>1)</sup>	<b>1756-83</b>	2CKA001753A0091	10
studio white	<b>1756-84</b>	2CKA001753A0092	10
grey metallic <sup>1)</sup>	<b>1756-803</b>	2CKA001753A0088	10
studio white, matt <sup>1)</sup>	<b>1756-884</b>	2CKA001753A0251	10
black matt <sup>1)</sup>	<b>1756-885</b>	2CKA001753A0252	10

<sup>1)</sup> Surface painted.



#### Cap for indication lamp

For indication lamps.  
Protection class (Device): IP 20

clear- transparent	<b>1565-11</b>	2CKA001565A0167	10
Red	<b>1565-12</b>	2CKA001565A0175	10
green	<b>1565-13</b>	2CKA001565A0183	10

### WaveLINE control elements

Product	Article-No.	Order-No.	Pack/Qty
---------	-------------	-----------	----------



#### Wall-mounted transmitter WaveLINE <sup>1)</sup> <sup>2)</sup>

##### 1-channel

1gang wall-mounted transmitter independent of mains power supply.  
With labelling field and labelling strip.  
For switching and dimming.  
For controlling blinds and light scenes.  
1 radio channel can be operated or up to 2 light scenes can be called up.  
For flush-mounted WaveLINE actuators 6701-101, 6702, 6703, 6704 and 6705-101.  
Compatible with WaveLINE KNX gateway TP-RF 6770.  
Send frequency: 868 MHz.  
Free-field range: approx. 100 m.  
Power supply: lithium button cell battery Type CR2032.  
Battery service life: typically 5 years, therefore practically maintenance-free.  
Automatic monitoring of battery life.  
Including fixing plate for mounting on smooth walls or on switch boxes.  
Control element: rocker switch left/right  
Display elements: LED to indicate the transmission  
Rated voltage: 3 V-  
Protection class (Device): IP 20  
Temperature range (Device): -5 °C to 45 °C  
Dimensions: (L x W x D): 63 mm x 63 mm x 16 mm

aluminium silver <sup>3)</sup>	<b>6731-83-500</b>	2CKA006730A0035	1/10
studio white	<b>6731-84-500</b>	2CKA006730A0038	1/10

<sup>1)</sup> Battery included in delivery.

<sup>2)</sup> For compatible lettering software, visit [www.BUSCH-JAEGER-labelingtool.com](http://www.BUSCH-JAEGER-labelingtool.com).

<sup>3)</sup> Surface painted.



#### Wall-mounted transmitter WaveLINE <sup>1)</sup> <sup>2)</sup>

##### 2-channel

2gang wall-mounted transmitter independent of mains power supply.  
With labelling field and labelling strip.  
For switching and dimming.  
For controlling blinds and light scenes.  
2 radio channels can be operated or up to 4 light scenes can be called up.  
For flush-mounted WaveLINE actuators 6701-101, 6702, 6703, 6704 and 6705-101.  
Send frequency: 868 MHz.  
Free-field range: approx. 100 m.  
Power supply: lithium button cell battery Type CR2032.  
Battery service life: typically 5 years, therefore practically maintenance-free.  
Automatic monitoring of battery life.  
Including fixing plate for mounting on smooth walls or on switch boxes.  
Control element: rocker switch left/right  
Display elements: LED to indicate the transmission  
Rated voltage: 3 V-  
Protection class (Device): IP 20  
Temperature range (Device): -5 °C to 45 °C  
Dimensions: (L x W x D): 63 mm x 63 mm x 16 mm

aluminium silver <sup>3)</sup>	<b>6732-83-500</b>	2CKA006730A0036	1/10
studio white	<b>6732-84-500</b>	2CKA006730A0039	1/10

<sup>1)</sup> Battery included in delivery.

<sup>2)</sup> For compatible lettering software, visit [www.BUSCH-JAEGER-labelingtool.com](http://www.BUSCH-JAEGER-labelingtool.com).

<sup>3)</sup> Surface painted.

## Busch-axcent®

### WaveLINE control elements

Product	Article-No.	Order-No.	Pack/Qty
	<b>Wall-mounted transmitter WaveLINE <sup>1)</sup> 2)</b> <b>4-channel</b> 4gang wall-mounted transmitter independent of mains power supply. With labelling field and labelling strip. For switching and dimming. For controlling blinds and light scenes. 4 radio channels can be operated or up to 8 light scenes can be called up. For flush-mounted WaveLINE actuators 6701-101, 6702, 6703, 6704 and 6705-101. Send frequency: 868 MHz. Free-field range: approx. 100 m. Power supply: lithium button cell battery Type CR2032. Battery service life: typically 5 years, therefore practically maintenance-free. Automatic monitoring of battery life. Including fixing plate for mounting on smooth walls or on switch boxes. Control element: rocker switch left/right Display elements: LED to indicate the transmission Rated voltage: 3 V- Protection class (Device): IP 20 Temperature range (Device): -5 °C to 45 °C Dimensions: (L x W x D): 63 mm x 63 mm x 16 mm		
aluminium silver <sup>3)</sup>	<b>6733-83-500</b>	2CKA006730A0037	1/10
studio white	<b>6733-84-500</b>	2CKA006730A0040	1/10

<sup>1)</sup> Battery included in delivery.

<sup>2)</sup> For compatible lettering software, visit [www.BUSCH-JAEGER-labelingtool.com](http://www.BUSCH-JAEGER-labelingtool.com).

<sup>3)</sup> Surface painted.

	<b>ZigBee Light Link wall-mounted transmitter</b> <b>1-channel</b> 1gang wall-mounted transmitter independent of mains power supply. For the wireless remote control of other ZigBee Light Link radio components. For saving and calling up 2 light scenes. For dimming a light scene. For combining with/integrating in other systems which operate with the ZigBee Light Link protocol, such as Philips hue. With labelling field. Without enclosed labelling sheet. Compatible lettering software is available at <a href="http://www.busch-jaeger-labelingtool.com">www.busch-jaeger-labelingtool.com</a> . Send/receive frequency: 2.4 GHz. Free-field range: approx. 100 m. Power supply: lithium button cell battery type CR2450 (included in scope of delivery) Battery service life: typically 3 years. Automatic monitoring of battery life. Including fixing plate for mounting on smooth walls or on switch boxes. Rated voltage: 3 V- Protection class (Device): IP 20 Temperature range (Device): -5 °C to 45 °C Dimensions: (L x W x D): 64 mm x 64 mm x 18 mm		
anthracite	<b>6735/01-81</b>	2CKA006730A0079	1
aluminium silver <sup>1)</sup>	<b>6735/01-83</b>	2CKA006730A0081	1
studio white	<b>6735/01-84</b>	2CKA006730A0082	1/10
grey metallic <sup>1)</sup>	<b>6735/01-803</b>	2CKA006730A0117	1
studio white, matt <sup>1)</sup>	<b>6735/01-884</b>	2CKA006730A0118	1
black matt <sup>1)</sup>	<b>6735/01-885</b>	2CKA006730A0119	1

<sup>1)</sup> Surface painted.

Product	Article-No.	Order-No.	Pack/Qty
	<b>ZigBee Light Link wall-mounted transmitter</b> <b>2-channel</b> 2gang wall-mounted transmitter independent of mains power supply. For the wireless remote control of other ZigBee Light Link radio components. For saving and calling up 4 light scenes. For dimming 2 light scenes. For combining with/integrating in other systems which operate with the ZigBee Light Link protocol, such as Philips hue. With labelling field. Without enclosed labelling sheet. Compatible lettering software is available at <a href="http://www.busch-jaeger-labelingtool.com">www.busch-jaeger-labelingtool.com</a> . Send/receive frequency: 2.4 GHz. Free-field range: approx. 100 m. Power supply: lithium button cell battery type CR2450 (included in scope of delivery) Battery service life: typically 3 years. Automatic monitoring of battery life. Including fixing plate for mounting on smooth walls or on switch boxes. Rated voltage: 3 V- Protection class (Device): IP 20 Temperature range (Device): -5 °C to 45 °C Dimensions: (L x W x D): 64 mm x 64 mm x 18 mm		
anthracite	<b>6736/01-81</b>	2CKA006730A0083	1
aluminium silver <sup>1)</sup>	<b>6736/01-83</b>	2CKA006730A0085	1
studio white	<b>6736/01-84</b>	2CKA006730A0086	1/10
grey metallic <sup>1)</sup>	<b>6736/01-803</b>	2CKA006730A0121	1
studio white, matt <sup>1)</sup>	<b>6736/01-884</b>	2CKA006730A0124	1
black matt <sup>1)</sup>	<b>6736/01-885</b>	2CKA006730A0125	1

<sup>1)</sup> Surface painted.

## Busch-axcent®

### WaveLINE control elements

Product	Article-No.	Order-No.	Pack/Qty
	<b>ZigBee Light Link wall-mounted transmitter 4-channel</b>		
	4gang wall-mounted transmitter independent of mains power supply. For the wireless remote control of other ZigBee Light Link radio components. For saving and calling up 8 light scenes. For dimming 4 light scenes. For combining with/integrating in other systems which operate with the ZigBee Light Link protocol, such as Philips hue. With labelling field. Without enclosed labelling sheet. Compatible lettering software is available at <a href="http://www.busch-jaeger-labelingtool.com">www.busch-jaeger-labelingtool.com</a> . Send/receive frequency: 2.4 GHz. Free-field range: approx. 100 m. Power supply: lithium button cell battery type CR2450 (included in scope of delivery) Battery service life: typically 3 years. Automatic monitoring of battery life. Including fixing plate for mounting on smooth walls or on switch boxes. Rated voltage: 3 V- Protection class (Device): IP 20 Temperature range (Device): -5 °C to 45 °C Dimensions: (L x W x D): 64 mm x 64 mm x 18 mm		
anthracite	<b>6737/01-81</b>	2CKA006730A0087	1
aluminium silver <sup>1)</sup>	<b>6737/01-83</b>	2CKA006730A0089	1
studio white	<b>6737/01-84</b>	2CKA006730A0090	1/10
grey metallic <sup>1)</sup>	<b>6737/01-803</b>	2CKA006730A0127	1
studio white, matt <sup>1)</sup>	<b>6737/01-884</b>	2CKA006730A0130	1
black matt <sup>1)</sup>	<b>6737/01-885</b>	2CKA006730A0131	1

<sup>1)</sup>Surface painted.

Product	Article-No.	Order-No.	Pack/Qty
	<b>ZigBee Light Link control element 1gang</b>		
	For wireless switching and dimming of electrical loads. For ZigBee Light Link flush-mounted inserts 6710 U, 6711 U and 6715 U. In connection with the ZigBee Light Link flush-mounted inserts 6711 U and 6715 U the top rocker is used to switch or dim the non-ZLL lamps connected to the flush-mounted insert directly. In the case of 6736 and 6737, the other keys can be used for saving, calling and dimming lightscenes. In combination with the ZigBee LightLink-UP insert 6710 U for storing and calling up 2 light scenes or dimming a light scene. For combining with/integrating in other systems which operate with the ZigBee Light Link protocol, such as Philips hue. Push-button function: Switching/dimming/light scenes. With labelling field. Without enclosed labelling sheet. Compatible lettering software is available at <a href="http://www.busch-jaeger-labelingtool.com">www.busch-jaeger-labelingtool.com</a> . Send/receive frequency: 2.4 GHz. Free-field range: approx. 100 m. Protection class (Device): IP 20 Temperature range (Device): -5 °C to 45 °C Dimensions: (L x W x D): 64 mm x 64 mm x 18 mm		
anthracite	<b>6735-81</b>	2CKA006730A0067	1
aluminium silver <sup>1)</sup>	<b>6735-83</b>	2CKA006730A0069	1
studio white	<b>6735-84</b>	2CKA006730A0070	1/10
grey metallic <sup>1)</sup>	<b>6735-803</b>	2CKA006730A0099	1
studio white, matt <sup>1)</sup>	<b>6735-884</b>	2CKA006730A0100	1
black matt <sup>1)</sup>	<b>6735-885</b>	2CKA006730A0101	1

<sup>1)</sup>Surface painted.

## Busch-axcent®

### WaveLINE control elements

Product	Article-No.	Order-No.	Pack/Qty
	<b>ZigBee Light Link control element 2gang</b>		
	For wireless switching and dimming of electrical loads. For ZigBee Light Link flush-mounted inserts 6710 U, 6711 U and 6715 U.		
	In connection with the ZigBee Light Link flush-mounted inserts 6711 U and 6715 U the top rocker is used to switch or dim the non-ZLL lamps connected to the flush-mounted insert directly. In the case of 6736 and 6737, the other keys can be used for saving, calling and dimming lightscenes.		
	In combination with the ZigBee LightLink-UP insert 6710 U for storing and calling up 4 light scenes or dimming 2 light scenes.		
	For combining with/integrating in other systems which operate with the ZigBee Light Link protocol, such as Philips hue.		
	With labelling field.		
	Without enclosed labelling sheet.		
	Compatible lettering software is available at <a href="http://www.busch-jaeger-labelingtool.com">www.busch-jaeger-labelingtool.com</a> .		
	Send/receive frequency: 2.4 GHz.		
	Free-field range: approx. 100 m.		
	Protection class (Device): IP 20		
	Temperature range (Device): -5 °C to 45 °C		
	Dimensions: (L x W x D): 64 mm x 64 mm x 18 mm		
anthracite	<b>6736-81</b>	2CKA006730A0071	1
aluminium silver <sup>1)</sup>	<b>6736-83</b>	2CKA006730A0073	1
studio white	<b>6736-84</b>	2CKA006730A0074	1/10
grey metallic <sup>1)</sup>	<b>6736-803</b>	2CKA006730A0105	1
studio white, matt <sup>1)</sup>	<b>6736-884</b>	2CKA006730A0106	1
black matt <sup>1)</sup>	<b>6736-885</b>	2CKA006730A0107	1

<sup>1)</sup>Surface painted.

Product	Article-No.	Order-No.	Pack/Qty
	<b>ZigBee Light Link control element 4gang</b>		
	For wireless switching and dimming of electrical loads. For ZigBee Light Link flush-mounted inserts 6710 U, 6711 U and 6715 U.		
	In connection with the ZigBee Light Link flush-mounted inserts 6711 U and 6715 U the top rocker is used to switch or dim the non-ZLL lamps connected to the flush-mounted insert directly. In the case of 6736 and 6737, the other keys can be used for saving, calling and dimming lightscenes.		
	In combination with the ZigBee LightLink-UP insert 6710 U for storing and calling up 8 light scenes or dimming 4 light scenes.		
	For combining with/integrating in other systems which operate with the ZigBee Light Link protocol, such as Philips hue.		
	With labelling field.		
	Without enclosed labelling sheet.		
	Compatible lettering software is available at <a href="http://www.busch-jaeger-labelingtool.com">www.busch-jaeger-labelingtool.com</a> .		
	Send/receive frequency: 2.4 GHz.		
	Free-field range: approx. 100 m.		
	Protection class (Device): IP 20		
	Temperature range (Device): -5 °C to 45 °C		
	Dimensions: (L x W x D): 64 mm x 64 mm x 18 mm		
anthracite	<b>6737-81</b>	2CKA006730A0075	1
aluminium silver <sup>1)</sup>	<b>6737-83</b>	2CKA006730A0077	1
studio white	<b>6737-84</b>	2CKA006730A0078	1/10
grey metallic <sup>1)</sup>	<b>6737-803</b>	2CKA006730A0111	1
studio white, matt <sup>1)</sup>	<b>6737-884</b>	2CKA006730A0112	1
black matt <sup>1)</sup>	<b>6737-885</b>	2CKA006730A0113	1

<sup>1)</sup>Surface painted.

# Busch-axcent®

## Busch-Infoline®

## Accessories

Product	Article-No.	Order-No.	Pack/Qty
	<b>Cover plate <sup>1) 2)</sup> 1gang, with labelling field</b> With operating knob. For signal/cancel push-button 1520/1 UK. For monitoring unit 1511 U. For Busch-Leakage guard insert 1531 U. With labelling field 61 x 20 mm. Protection class (Device): IP 20 Dimensions: (L x W x D): 63.5 mm x 63.5 mm x 11.1 mm		
studio white	<b>1571 CN-84</b>	2CKA001582A0346	10

<sup>1)</sup> For compatible lettering software, visit [www.BUSCH-JAEGER-labelingtool.com](http://www.BUSCH-JAEGER-labelingtool.com).

<sup>2)</sup> Can also be used for Busch-axcent®, solo®, and carat®.

	<b>Cover plate <sup>1) 2)</sup> 2gang, with labelling field</b> With operating knob. For signal push-button insert 1520/1 UKZ. With labelling field 61 x 20 mm. With exchangeable inlays in red and green for the individual designation of the operating knob. Protection class (Device): IP 20 Dimensions: (L x W x D): 63.5 mm x 63.5 mm x 11.1 mm		
studio white	<b>1572 CN-84</b>	2CKA001582A0348	10

<sup>1)</sup> For compatible lettering software, visit [www.BUSCH-JAEGER-labelingtool.com](http://www.BUSCH-JAEGER-labelingtool.com).

<sup>2)</sup> Can also be used for Busch-axcent®, solo®, and carat®.

	<b>Cover plate <sup>1) 2)</sup> with red and neutral light panel and labelling field</b> For Alarm Control Unit insert 1515 U-12. For Busch-Alarm signal insert 1563 U-12. For indication lamp insert 1564 U-1x. With labelling field 61 x 61 mm. Protection class (Device): IP 20 Dimensions: (L x W x D): 63.5 mm x 63.5 mm x 11.1 mm		
studio white	<b>1573 CN-84</b>	2CKA001582A0350	10

<sup>1)</sup> For compatible lettering software, visit [www.BUSCH-JAEGER-labelingtool.com](http://www.BUSCH-JAEGER-labelingtool.com).

<sup>2)</sup> Can also be used for Busch-axcent®, solo®, and carat®.

	<b>Cover plate <sup>1) 2)</sup> 6gang, illuminable, with labelling field</b> For signal panel insert 1566 U. With labelling field 61 x 61 mm. Protection class (Device): IP 20 Dimensions: (L x W x D): 63.5 mm x 63.5 mm x 11.1 mm		
studio white	<b>1575 CN-84</b>	2CKA001582A0353	10

<sup>1)</sup> For compatible lettering software, visit [www.BUSCH-JAEGER-labelingtool.com](http://www.BUSCH-JAEGER-labelingtool.com).

<sup>2)</sup> Can also be used for Busch-axcent®, solo®, and carat®.

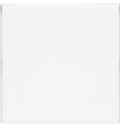
	<b>Cover plate <sup>1) 2)</sup> with labelling field</b> For power supply insert 1518 U. For relay insert 1539 U. For signal generator insert 1561 U-.... With labelling field 61 x 61 mm. Protection class (Device): IP 20 Dimensions: (L x W x D): 63.5 mm x 63.5 mm x 11.1 mm		
studio white	<b>1576 CN-84</b>	2CKA001582A0355	10

<sup>1)</sup> For compatible lettering software, visit [www.BUSCH-JAEGER-labelingtool.com](http://www.BUSCH-JAEGER-labelingtool.com).

<sup>2)</sup> Can also be used for Busch-axcent®, solo®, and carat®.

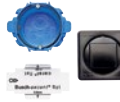
Product	Article-No.	Order-No.	Pack/Qty
	<b>Mounting set Busch-axcent® flat <sup>1) 2) 3)</sup></b> For flat flush-mounted installation, stonework Suitable for Busch-axcent® frames without carrier. With plastering moulding tool and positioning device. With integrated RFID-chip for easy detection. With vertically adjustable rotary ring. With Torx/slotted screws. With variable basement depth. Mounting boxes are combinable directly. With flex knockouts for cables or pipes. The boxes need to be plastered. Hole size : 82 mm Protection class (Device): IP 20 Dimensions: (L x W x D): 82 mm		
	<b>1gang</b>		
	<b>3048/10</b>	2CKA001740A0061	1
	<b>2gang</b>		
	<b>3048/20</b>	2CKA001740A0062	1
	<b>3gang</b>		
	<b>3048/30</b>	2CKA001740A0063	1
	<b>4gang</b>		
	<b>3048/40</b>	2CKA001740A0064	1
	<b>5gang</b>		
	<b>3048/50</b>	2CKA001740A0065	1

<sup>1)</sup> Carrier needs to remove from Busch-axcent® cover frame.

<sup>2)</sup> RFID = Radio Frequency Identification

<sup>3)</sup> Not suitable for fixing claws.

	<b>Mounting set Busch-axcent® flat <sup>1)</sup></b> For flat flush-mounted installation, hollow wall Suitable for Busch-axcent® frames without carrier. For double planking. With positioning device and adapter rings. Suitable for drywalls and plasterboards for 9,5 mm, 10 mm and 12,5 mm. With Torx/slotted screws. Mounting boxes are combinable directly. With flex knockouts for cables or pipes. Fast installation via cable strap latches. A 74 mm diameter moulding cutter with countersink is needed. Hole size : 74 mm Protection class (Device): IP 20		
	<b>1gang</b>		
	<b>3058/10</b>	2CKA001740A0072	1
	<b>2gang</b>		
	<b>3058/20</b>	2CKA001740A0073	1
	<b>3gang</b>		
	<b>3058/30</b>	2CKA001740A0074	1
	<b>4gang</b>		
	<b>3058/40</b>	2CKA001740A0075	1
	<b>5gang</b>		
	<b>3058/50</b>	2CKA001740A0076	1

<sup>1)</sup> Carrier needs to remove from Busch-axcent® cover frame.

## Busch-axcent®

### Accessories

Product	Article-No.	Order-No.	Pack/Qty
 <p><b>Mounting set Busch-axcent® flat <sup>1)</sup></b>            For flat flush-mounted installation, concrete construction            Suitable for Busch-axcent® frames without carrier.            Suitable for prefabricated and in-situ concrete directly onto the formwork.            Delivered with a lid with distance positioning device.            Fixing exclusively and directly to formwork by nailing or hot gluing.            With Torx/slotted screws.            Mounting boxes are combinable directly.            With flex knockouts for pipes.            Protection class (Device): IP 20</p>	<b>1gang</b>		
	<b>3068/10</b>	2CKA001740A0083	1
	<b>2gang</b>		
	<b>3068/20</b>	2CKA001740A0084	1
	<b>3gang</b>		
	<b>3068/30</b>	2CKA001740A0085	1
	<b>4gang</b>		
<b>3068/40</b>	2CKA001740A0086	1	
<b>5gang</b>			
<b>3068/50</b>	2CKA001740A0087	1	

<sup>1)</sup> Carrier needs to remove from Busch-axcent® cover frame.

 <p><b>RFID-Detector <sup>1)</sup></b>            To recover of RFID-chips.            Power supply: 9V alkaline cell (included in delivery).            Protection class (Device): IP 20</p>	<b>3049</b>	2CKA001740A0070	1
--	-------------	-----------------	---

<sup>1)</sup> RFID = Radio Frequency Identification

 <p><b>Compensation rings for flush-mounted boxes</b>            For additional compensation for too deep mounted flush-mounted boxes.            Adjustment height: 2,6 mm            Protection class (Device): IP 20</p>	<b>3057</b>	2CKA001740A0081	10
--	-------------	-----------------	----

 <p><b>Extension of claws <sup>1)</sup></b>            For the installation of flush-mounted SCHUKO® socket outlets and also switches, push-buttons, etc. and deeply installed flush-mounted boxes.            Protection class (Device): IP 20</p>	<b>2148</b>	2CKA002148A0120	100
--	-------------	-----------------	-----

<sup>1)</sup> Not suitable for types 2000/3 US, 2000/6/2 US, 2000/6/6 US-101 and double socket outlets.

Product	Article-No.	Order-No.	Pack/Qty
 <p><b>Braille symbol</b>            self-adhesive (transparent) for cover 2506-xxx            Protection class (Device): IP 20</p>	<b>light</b>		
	<b>2144 LI</b>	2CKA001714A0295	10/1000
	<b>bell</b>		
	<b>2144 KI</b>	2CKA001714A0296	10/1000
<b>key</b>			
<b>2144 TR</b>	2CKA001714A0297	10/1000	

 <p><b>Braille symbol</b>  <b>socket outlet</b>            self-adhesive, transparent for SCHUKO® socket outlets with hinged lid 20 EUK-xxx            Protection class (Device): IP 20</p>	<b>2144 ST</b>	2CKA001714A0298	10/1000
---	----------------	-----------------	---------

 <p><b>DIN A 4 labelling sheet <sup>1)</sup></b>  <b>plastic foil</b>            Suitable for all to be labeled Busch-Jaeger devices.            For laser printer.            The text of the foil is printed via the Busch-Jaeger labeling service.            Dimensions: (L x W x D): 297 mm</p>	translucent	<b>1799/02</b>	2CKA001799A0959	1
	transparent	<b>1799/03</b>	2CKA001799A0960	1

<sup>1)</sup> 1 piece = 1 sheet.

 <p><b>RC suppressor</b>            For protection against the damage or destruction of electronic devices due to overvoltages.            For wiring network-interconnected inductivities (e.g. relay, protection, fluorescent lamps, transformers, etc.).            Eliminates functional disturbances on electronic devices, e.g. automatic circuit reclosure (clocking) of a movement detector.            Dimensions: diameter 25 mm, length 35 mm, length of the connecting cable approx. 100 mm.            Rated voltage: 230 V~, +10 % / -10 %            Rated frequency: 50 Hz</p>	<b>6899</b>	2CKA006899A0231	10
---	-------------	-----------------	----

# Busch-axcent®

## Cover frames

Product	Article-No.	Order-No.	Pack/Qty
	<b>Cover frame <sup>1)</sup> 1gang frame</b> Protection class (Device): IP 20 Dimensions: (L x W x D): 91 mm x 91 mm x 11 mm		
studio white	<b>1721-284</b>	2CKA001754A4331	10
black	<b>1721-281</b>	2CKA001754A4409	10
maison-beige	<b>1721-299-500</b>	2CKA001754A4481	10
entrée-grey	<b>1721-291-500</b>	2CKA001754A4471	10
château-black	<b>1721-295-500</b>	2CKA001754A4491	10
yellow	<b>1721-285</b>	2CKA001754A4334	10
green	<b>1721-286</b>	2CKA001754A4337	10
Red	<b>1721-287</b>	2CKA001754A4340	10
blue	<b>1721-288</b>	2CKA001754A4343	10

<sup>1)</sup> Flat mounting possible, a mounting set flat Art.No. 30x8/xx must be used as a flush-mounted box.

	<b>Cover frame <sup>1)</sup> 2gang frame</b> For vertical or horizontal installation. Protection class (Device): IP 20 Dimensions: (L x W x D): 162 mm x 91 mm x 11 mm		
studio white	<b>1722-284</b>	2CKA001754A4332	10
black	<b>1722-281</b>	2CKA001754A4410	10
maison-beige	<b>1722-299-500</b>	2CKA001754A4482	10
entrée-grey	<b>1722-291-500</b>	2CKA001754A4472	10
château-black	<b>1722-295-500</b>	2CKA001754A4492	10
yellow	<b>1722-285</b>	2CKA001754A4335	10
green	<b>1722-286</b>	2CKA001754A4338	10
Red	<b>1722-287</b>	2CKA001754A4341	10
blue	<b>1722-288</b>	2CKA001754A4344	10

<sup>1)</sup> Flat mounting possible, a mounting set flat Art.No. 30x8/xx must be used as a flush-mounted box.

	<b>Cover frame <sup>1)</sup> 3gang frame</b> For vertical or horizontal installation. Protection class (Device): IP 20 Dimensions: (L x W x D): 233 mm x 91 mm x 11 mm		
studio white	<b>1723-284</b>	2CKA001754A4333	10
black	<b>1723-281</b>	2CKA001754A4411	10
maison-beige	<b>1723-299-500</b>	2CKA001754A4483	10
entrée-grey	<b>1723-291-500</b>	2CKA001754A4473	10
château-black	<b>1723-295-500</b>	2CKA001754A4493	10
yellow	<b>1723-285</b>	2CKA001754A4336	10
green	<b>1723-286</b>	2CKA001754A4339	10
Red	<b>1723-287</b>	2CKA001754A4342	10
blue	<b>1723-288</b>	2CKA001754A4345	10

<sup>1)</sup> Flat mounting possible, a mounting set flat Art.No. 30x8/xx must be used as a flush-mounted box.

Product	Article-No.	Order-No.	Pack/Qty
	<b>Cover frame <sup>1)</sup> 4gang frame</b> For vertical or horizontal installation. Protection class (Device): IP 20 Dimensions: (L x W x D): 304 mm x 91 mm x 11 mm		
studio white	<b>1724-284</b>	2CKA001754A4346	1
black	<b>1724-281</b>	2CKA001754A4412	1
maison-beige	<b>1724-299-500</b>	2CKA001754A4484	1
entrée-grey	<b>1724-291-500</b>	2CKA001754A4474	1
château-black	<b>1724-295-500</b>	2CKA001754A4494	1
yellow	<b>1724-285</b>	2CKA001754A4348	1
green	<b>1724-286</b>	2CKA001754A4350	1
Red	<b>1724-287</b>	2CKA001754A4352	1
blue	<b>1724-288</b>	2CKA001754A4354	1

<sup>1)</sup> Flat mounting possible, a mounting set flat Art.No. 30x8/xx must be used as a flush-mounted box.





	<b>Cover frame <sup>1)</sup> 5gang frame</b> For vertical or horizontal installation. Protection class (Device): IP 20 Dimensions: (L x W x D): 375 mm x 91 mm x 11 mm		
studio white <sup>1)</sup>	<b>1725-284</b>	2CKA001754A4347	1
black <sup>1)</sup>	<b>1725-281</b>	2CKA001754A4413	1
maison-beige	<b>1725-299-500</b>	2CKA001754A4485	1
entrée-grey <sup>1)</sup>	<b>1725-291-500</b>	2CKA001754A4475	1
château-black <sup>1)</sup>	<b>1725-295-500</b>	2CKA001754A4495	1
yellow <sup>1)</sup>	<b>1725-285</b>	2CKA001754A4349	1
green <sup>1)</sup>	<b>1725-286</b>	2CKA001754A4351	1
Red <sup>1)</sup>	<b>1725-287</b>	2CKA001754A4353	1
blue <sup>1)</sup>	<b>1725-288</b>	2CKA001754A4355	1

<sup>1)</sup> Flat mounting possible, a mounting set flat Art.No. 30x8/xx must be used as a flush-mounted box.



## Busch-axcent® flat

### Cover frames

Product	Article-No.	Order-No.	Pack/Qty
	<b>Cover frame Busch-axcent® flat 1gang frame</b> For flat flush mounting. Only suitable with Busch-axcent® flat mounting set. Without carrier. Protection class (Device): IP 20 Dimensions: (L x W x D): 91 mm x 91 mm x 11 mm		
black	<b>1721-281/11</b>	2CKA001753A4126	10
studio white	<b>1721-284/11</b>	2CKA001753A4121	10
	<b>Cover frame Busch-axcent® flat 2gang frame</b> For flat flush mounting. Only suitable with Busch-axcent® flat mounting set. For vertical or horizontal installation. Protection class (Device): IP 20 Dimensions: (L x W x D): 162 mm x 91 mm x 11 mm		
black	<b>1722-281/11</b>	2CKA001753A4127	10
studio white	<b>1722-284/11</b>	2CKA001753A4122	10
	<b>Cover frame Busch-axcent® flat 3gang frame</b> For flat flush mounting. Only suitable with Busch-axcent® flat mounting set. For vertical or horizontal installation. Protection class (Device): IP 20 Dimensions: (L x W x D): 233 mm x 91 mm x 11 mm		
black	<b>1723-281/11</b>	2CKA001753A4128	10
studio white	<b>1723-284/11</b>	2CKA001753A4123	10
	<b>Cover frame Busch-axcent® flat 4gang frame</b> For flat flush mounting. Only suitable with Busch-axcent® flat mounting set. For vertical or horizontal installation. Protection class (Device): IP 20 Dimensions: (L x W x D): 304 mm x 91 mm x 11 mm		
black	<b>1724-281/11</b>	2CKA001753A4129	1
studio white	<b>1724-284/11</b>	2CKA001753A4124	1
	<b>Cover frame Busch-axcent® flat 5gang frame</b> For flat flush mounting. Only suitable with Busch-axcent® flat mounting set. For vertical or horizontal installation. Protection class (Device): IP 20 Dimensions: (L x W x D): 375 mm x 91 mm x 11 mm		
black	<b>1725-281/11</b>	2CKA001753A4130	1
studio white	<b>1725-284/11</b>	2CKA001753A4125	1

## Busch-axcent® pur

### Cover frames

Product	Article-No.	Order-No.	Pack/Qty
	<b>Cover frame 1gang frame</b> Protection class (Device): IP 20 Dimensions: (L x W x D): 91 mm x 91 mm x 11 mm		
slate grey <sup>1)</sup> <sup>2)</sup> <sup>3)</sup> <sup>4)</sup>	<b>1721-290</b>	2CKA001754A4805	1
concrete grey <sup>1)</sup> <sup>2)</sup> <sup>3)</sup> <sup>4)</sup>	<b>1721-298</b>	2CKA001754A4795	1
paper blue <sup>1)</sup> <sup>2)</sup> <sup>3)</sup>	<b>1721-248</b>	2CKA001754A4785	1
paper brown <sup>1)</sup> <sup>2)</sup> <sup>3)</sup>	<b>1721-243</b>	2CKA001754A4790	1
glass coral	<b>1721-227</b>	2CKA001754A4765	1
glass avocado	<b>1721-226</b>	2CKA001754A4770	1
glass purple	<b>1721-223</b>	2CKA001754A4775	1
glass oyster	<b>1721-229</b>	2CKA001754A4780	1
glass ocean	<b>1721-228</b>	2CKA001754A4755	1
glass sun	<b>1721-225</b>	2CKA001754A4760	1
platinum <sup>5)</sup> <sup>6)</sup>	<b>1721-270-500</b>	2CKA001754A4688	1
black matt <sup>5)</sup> <sup>6)</sup>	<b>1721-275-500</b>	2CKA001754A4708	1
titanium <sup>5)</sup> <sup>6)</sup>	<b>1721-276-500</b>	2CKA001754A4698	1
white glass	<b>1721-280</b>	2CKA001754A4437	1
glass black	<b>1721-245</b>	2CKA001754A4800	1

<sup>1)</sup> Genuine material with an individual surface.

<sup>2)</sup> Genuine material with an open-pore surface.

<sup>3)</sup> Each cover frame is unique in structure and color nuance.

<sup>4)</sup> Genuine material with reduced resistance against mechanical stress.

<sup>5)</sup> Real metal surface.

<sup>6)</sup> Flat mounting possible, a mounting set flat Art.No. 30x8/xx must be used as a flush-mounted box.

## Busch-axcent® pur

### Cover frames

Product	Article-No.	Order-No.	Pack/Qty
	<b>Cover frame 2gang frame</b> For vertical or horizontal installation. Protection class (Device): IP 20 Dimensions: (L x W x D): 162 mm x 91 mm x 11 mm		
slate grey <sup>1)</sup> <sup>2)</sup> <sup>3)</sup> <sup>4)</sup>	<b>1722-290</b>	2CKA001754A4806	1
concrete grey <sup>1)</sup> <sup>2)</sup> <sup>3)</sup> <sup>4)</sup>	<b>1722-298</b>	2CKA001754A4796	1
paper blue <sup>1)</sup> <sup>2)</sup> <sup>3)</sup>	<b>1722-248</b>	2CKA001754A4786	1
paper brown <sup>1)</sup> <sup>2)</sup> <sup>3)</sup>	<b>1722-243</b>	2CKA001754A4791	1
glass coral	<b>1722-227</b>	2CKA001754A4766	1
glass avocado	<b>1722-226</b>	2CKA001754A4771	1
glass purple	<b>1722-223</b>	2CKA001754A4776	1
glass oyster	<b>1722-229</b>	2CKA001754A4781	1
glass ocean	<b>1722-228</b>	2CKA001754A4756	1
glass sun	<b>1722-225</b>	2CKA001754A4761	1
platinum <sup>5)</sup> <sup>6)</sup>	<b>1722-270-500</b>	2CKA001754A4689	1
black matt <sup>5)</sup> <sup>6)</sup>	<b>1722-275-500</b>	2CKA001754A4709	1
titanium <sup>5)</sup> <sup>6)</sup>	<b>1722-276-500</b>	2CKA001754A4699	1
white glass	<b>1722-280</b>	2CKA001754A4438	1
glass black	<b>1722-245</b>	2CKA001754A4801	1

<sup>1)</sup> Genuine material with an individual surface.

<sup>2)</sup> Genuine material with an open-pore surface.

<sup>3)</sup> Each cover frame is unique in structure and color nuance.

<sup>4)</sup> Genuine material with reduced resistance against mechanical stress.

<sup>5)</sup> Real metal surface.

<sup>6)</sup> Flat mounting possible, a mounting set flat Art.No. 30x8/xx must be used as a flush-mounted box.

Product	Article-No.	Order-No.	Pack/Qty
	<b>Cover frame 3gang frame</b> For vertical or horizontal installation. Protection class (Device): IP 20 Dimensions: (L x W x D): 233 mm x 91 mm x 11 mm		
slate grey <sup>1)</sup> <sup>2)</sup> <sup>3)</sup> <sup>4)</sup>	<b>1723-290</b>	2CKA001754A4807	1
concrete grey <sup>1)</sup> <sup>2)</sup> <sup>3)</sup> <sup>4)</sup>	<b>1723-298</b>	2CKA001754A4797	1
paper blue <sup>1)</sup> <sup>2)</sup> <sup>3)</sup>	<b>1723-248</b>	2CKA001754A4787	1
paper brown <sup>1)</sup> <sup>2)</sup> <sup>3)</sup>	<b>1723-243</b>	2CKA001754A4792	1
glass coral	<b>1723-227</b>	2CKA001754A4767	1
glass avocado	<b>1723-226</b>	2CKA001754A4772	1
glass purple	<b>1723-223</b>	2CKA001754A4777	1
glass oyster	<b>1723-229</b>	2CKA001754A4782	1
glass ocean	<b>1723-228</b>	2CKA001754A4757	1
glass sun	<b>1723-225</b>	2CKA001754A4762	1
platinum <sup>5)</sup> <sup>6)</sup>	<b>1723-270-500</b>	2CKA001754A4690	1
black matt <sup>5)</sup> <sup>6)</sup>	<b>1723-275-500</b>	2CKA001754A4710	1
titanium <sup>5)</sup> <sup>6)</sup>	<b>1723-276-500</b>	2CKA001754A4700	1
white glass	<b>1723-280</b>	2CKA001754A4439	1
glass black	<b>1723-245</b>	2CKA001754A4802	1

<sup>1)</sup> Genuine material with an individual surface.

<sup>2)</sup> Genuine material with an open-pore surface.

<sup>3)</sup> Each cover frame is unique in structure and color nuance.

<sup>4)</sup> Genuine material with reduced resistance against mechanical stress.

<sup>5)</sup> Real metal surface.

<sup>6)</sup> Flat mounting possible, a mounting set flat Art.No. 30x8/xx must be used as a flush-mounted box.

## Busch-axcent® pur

### Cover frames

Product	Article-No.	Order-No.	Pack/Qty
	<b>Cover frame 4gang frame</b> For vertical or horizontal installation. Protection class (Device): IP 20 Dimensions: (L x W x D): 304 mm x 91 mm x 11 mm		
slate grey <sup>1)</sup> <sup>2)</sup> <sup>3)</sup> <sup>4)</sup>	<b>1724-290</b>	2CKA001754A4808	1
concrete grey <sup>1)</sup> <sup>2)</sup> <sup>3)</sup> <sup>4)</sup>	<b>1724-298</b>	2CKA001754A4798	1
paper blue <sup>1)</sup> <sup>2)</sup> <sup>3)</sup>	<b>1724-248</b>	2CKA001754A4788	1
paper brown <sup>1)</sup> <sup>2)</sup> <sup>3)</sup>	<b>1724-243</b>	2CKA001754A4793	1
glass coral	<b>1724-227</b>	2CKA001754A4768	1
glass avocado	<b>1724-226</b>	2CKA001754A4773	1
glass purple	<b>1724-223</b>	2CKA001754A4778	1
glass oyster	<b>1724-229</b>	2CKA001754A4783	1
glass ocean	<b>1724-228</b>	2CKA001754A4758	1
glass sun	<b>1724-225</b>	2CKA001754A4763	1
platinum <sup>5)</sup> <sup>6)</sup>	<b>1724-270-500</b>	2CKA001754A4691	1
black matt <sup>5)</sup> <sup>6)</sup>	<b>1724-275-500</b>	2CKA001754A4711	1
titanium <sup>5)</sup> <sup>6)</sup>	<b>1724-276-500</b>	2CKA001754A4701	1
white glass	<b>1724-280</b>	2CKA001754A4440	1
glass black	<b>1724-245</b>	2CKA001754A4803	1

<sup>1)</sup> Genuine material with an individual surface.

<sup>2)</sup> Genuine material with an open-pore surface.

<sup>3)</sup> Each cover frame is unique in structure and color nuance.

<sup>4)</sup> Genuine material with reduced resistance against mechanical stress.

<sup>5)</sup> Real metal surface.

<sup>6)</sup> Flat mounting possible, a mounting set flat Art.No. 30x8/xx must be used as a flush-mounted box.

Product	Article-No.	Order-No.	Pack/Qty
	<b>Cover frame 5gang frame</b> For vertical or horizontal installation. Protection class (Device): IP 20 Dimensions: (L x W x D): 375 mm x 91 mm x 11 mm		
slate grey <sup>1)</sup> <sup>2)</sup> <sup>3)</sup> <sup>4)</sup>	<b>1725-290</b>	2CKA001754A4809	1
concrete grey <sup>1)</sup> <sup>2)</sup> <sup>3)</sup> <sup>4)</sup>	<b>1725-298</b>	2CKA001754A4799	1
paper blue <sup>1)</sup> <sup>2)</sup> <sup>3)</sup>	<b>1725-248</b>	2CKA001754A4789	1
paper brown <sup>1)</sup> <sup>2)</sup> <sup>3)</sup>	<b>1725-243</b>	2CKA001754A4794	1
glass coral	<b>1725-227</b>	2CKA001754A4769	1
glass avocado	<b>1725-226</b>	2CKA001754A4774	1
glass purple	<b>1725-223</b>	2CKA001754A4779	1
glass oyster	<b>1725-229</b>	2CKA001754A4784	1
glass ocean	<b>1725-228</b>	2CKA001754A4759	1
glass sun	<b>1725-225</b>	2CKA001754A4764	1
platinum <sup>5)</sup> <sup>6)</sup>	<b>1725-270-500</b>	2CKA001754A4692	1
black matt <sup>5)</sup>	<b>1725-275-500</b>	2CKA001754A4712	1
titanium <sup>5)</sup> <sup>6)</sup>	<b>1725-276-500</b>	2CKA001754A4702	1
white glass	<b>1725-280</b>	2CKA001754A4441	1
glass black	<b>1725-245</b>	2CKA001754A4804	1

<sup>1)</sup> Genuine material with an individual surface.

<sup>2)</sup> Genuine material with an open-pore surface.

<sup>3)</sup> Each cover frame is unique in structure and color nuance.

<sup>4)</sup> Genuine material with reduced resistance against mechanical stress.

<sup>5)</sup> Real metal surface.

<sup>6)</sup> Flat mounting possible, a mounting set flat Art.No. 30x8/xx must be used as a flush-mounted box.