

PRODUCT DATASHEET

LN COMP SWITCH 900 12 W 3000 K

LINEAR COMPACT SWITCH | Compact single or light line luminaire with switch



Areas of application

- Direct replacement for luminaires with fluorescent lamps
- Indoor applications
- Corridors, entrance areas, stairwells, living rooms, basements
- Accent lighting
- Public areas
- Cove lighting
- Shelves, furniture integration or under cabinet mounting
- Seamless linear lighting



Product benefits

- Compact dimensions
- Little space required thanks to compact dimensions
- Seamless connection of up to 10 luminaires in a line
- Handy switch directly installed on the luminaire
- Low flicker light thanks to special electronic control gear
- Flexible installation in 2 different angles with 2 different mounting options
- Flexible application due to a wide range of available lengths of 300 to 1500 mm.
- Angled connection possible with included cable

Product features

- Built-in switch
- Up to 10 luminaires connectable



- Translucent end caps
- Versions with luminous flux 400...1900 lm available
- 5 different lengths available
- High luminous efficacy: up to 112 lm/W
- Glow Wire Test according to IEC 60695-2-12: 850 °C

TECHNICAL DATA

Electrical data

Nominal wattage	12.00 W
Nominal voltage	220...240 V
Mains frequency	50...60 Hz
Nominal current	0.08 A
Inrush current	15.0 A
Inrush current time T_{h50}	150 μ s
Max. number of luminaires per miniature circuit breaker B16	40
Max. number of luminaires per miniature circuit breaker C10	32
Max. number of luminaires per miniature circuit breaker C16	51
Power factor λ	> 0.5
Total harmonic distortion	89 %
Protection class	II
Operating mode	Integrated LED driver

Photometrical data

Luminous flux	1200 lm
Luminous efficacy	100 lm/W
Color temperature	3000 K
Light color (designation)	Warm White
Color rendering index Ra	> 80
Standard deviation of color matching	< 5 sdc _m
Low flicker	Yes
Photobiological safety group acc. to EN62778	RG0
Beam angle	140 °

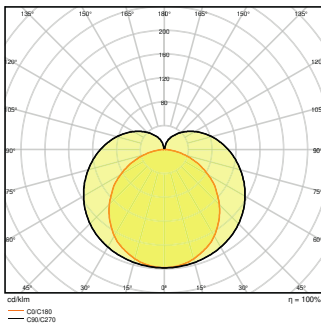

LN COMP SWITCH 900 12W
3000K 230V IP20

Dimensions & Weight

Length	873.00 mm
Width	28.00 mm
Height	36.00 mm
Product weight	300.00 g

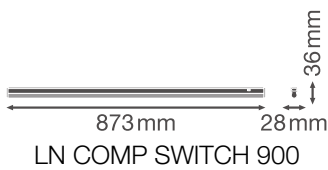

Materials & Colors

Product color	White
Housing color	White
Body material	Polycarbonate (PC)
Cover material	Polycarbonate (PC)
Light emitting surface material	Polycarbonate (PC)
Glow Wire Test according to IEC 60695-2-12	850 °C
Mercury content	0.0 mg

Application & Mounting

Ambient temperature range	-20...+40 °C
---------------------------	--------------

Type of connection	Screw terminal, 2-Pole (L,N)
Type of protection	IP20
Protection class IK (shock resistance)	IK03
Dimmable	No
Mounting type	Surface
Mounting location	Ceiling / Wall
Application environment	Indoor
With light source	Yes

Lifespan

Lifespan L70/B50 at 25 °C	50000 h ¹⁾
Lifespan L80/B10 at 25 °C	40000 h ¹⁾
Lifespan L80/B50 at 25 °C	40000 h
Lifespan L90/B10 at 25 °C	30000 h
Number of switching cycles	100000

1) t[h]: L70 / B50 @ 25 °C (Ta), t[h]: L80 / B10 @ 25 °C (Ta), t[h]: L90 / B10 @ 25 °C (Ta)

Control gear

Output current	160 mA
----------------	--------

Certificates & Standards

Standards	CE / CB / TÜV SÜD / EAC / EPD
Luminaire with limited surface temperature, "D sign"	No
Ball shot safe	No
EPD	LEDV-00018-V01.01-EN
Replaceable light source (EPREL)	Not replaceable

Additional product data

BEG eligible	No
--------------	----

EQUIPMENT / ACCESSORIES















- Equipped with power plug, cable connector and line adapter for connecting further luminaires
- Mounting material for wall and ceiling installations included

Safety advice

- All electrical connections must be made by a qualified person.

- To reduce the risk of strangulation the flexible wiring connected to this luminaire shall be effectively fixed to the wall if the wiring is within arm's reach.

DOWNLOAD DATA

Documents and certificates		Document name
	User Instruction / Safety Instructions	Linear_Compact_Switch_UI
	On-Pack-Info	Legal Insert Linear Compact
	Legal information	LS Insert LN COMP HO and SWITCH
	Legal information	Informationstext 18 Abs 4 ElektroG
	Declarations of conformity	EU Declaration of Conformity Linear Comp Switch and HO LEDV
	Declarations of conformity	Attestation of Conformity Linear Comp
	Declarations Of Conformity UKCA	LN COMP SWITCH
Photometric and lighting design files		Document name
	IES file (IES)	LN COMP SWITCH 900 12W 3000K 230V IP20
	LDT file (Eulumdat)	LN COMP SWITCH 900 12W 3000K 230V IP20
	ULD file (DIALux)	LINEARCOMPACTSWITCH90012W3000K
	ROLF file (RELUX)	LN COMP SWITCH 900
	UGR file (UGR table)	LN COMP SWITCH 900 12W 3000K 230V IP20
	LDC typ polar	LN COMP SWITCH 900 12W 3000K 230V IP20
CAD/BIM files		Document name
	BIM_Revit_3D	Linear Compact
	CAD_STEP_3D	LN COMP SWITCH 900

Tender texts	Document name
 Tender documents	LINEAR COMPACT SWITCH 900 12 W 3000 K-EN

LOGISTICAL DATA

Product code	Packaging unit (Pieces/Unit)	Dimensions (length x width x height)	Gross weight	Volume
4058075106192	Folding box 1	44 mm x 34 mm x 1,086 mm	386.00 g	1.62 dm ³
4058075106208	Shipping box 25	1,095 mm x 228 mm x 175 mm	9960.00 g	43.69 dm ³

The mentioned product code describes the smallest quantity unit which can be ordered. One shipping unit can contain one or more single products. When placing an order, for the quantity please enter single or multiples of a shipping unit.

ADDITIONAL CATALOG INFORMATION

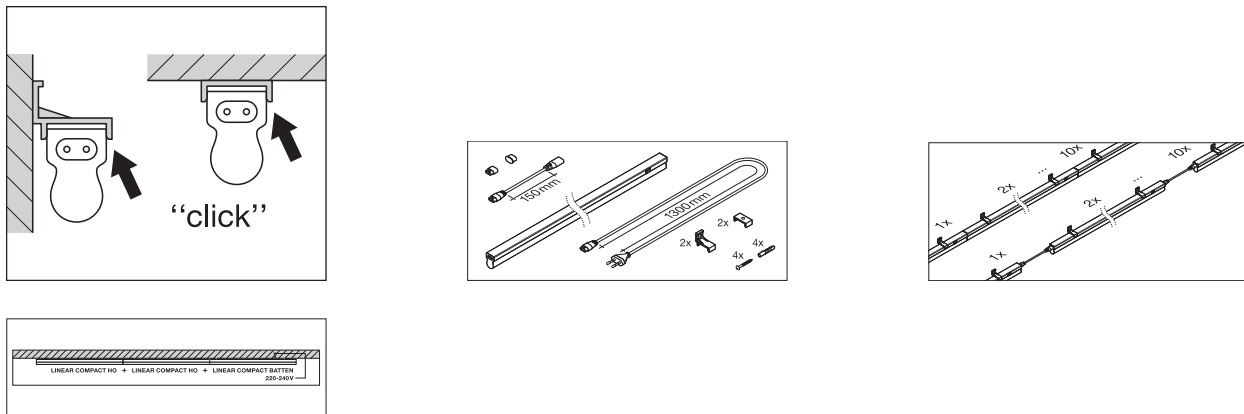

References / Links

– For Guarantee see www.ledvance.com/guarantee

DISCLAIMER

Subject to change without notice. Errors and omission excepted. Always make sure to use the most recent release.